

# ELFIN User Guide



# Table of content

Introduction.....	2
General Safety Information.....	3
1. Learn More About the Nova3D ELFIN.....	7
2. What's in the Box.....	9
3. Main Components.....	11
4. Nova3D Printing Technology Glossary.....	13
5. First Use Preparations.....	16
6. Connecting the Printer to a Network.....	18
7. Firmware Update.....	21
8. Navigating Through the Menu.....	22
9. NovaMake Software.....	25
1. User Interface.....	28
2. Import Model File.....	34
3. Adding Support.....	35
4. Slice Configuration.....	37
5. Connectivity.....	39
6. Uploading Slice File.....	40
10. Starting and Post-Processing.....	42
a. Preparation for Printing.....	42
b. Starting.....	43
c. Post-Processing.....	47
d. Changing the Resin.....	49
11. Available Materials.....	52
12. Basic Maintenance and Service Work.....	53
13. Support and Troubleshooting.....	55
14. Specification.....	57
15. Recycling.....	59

# Introduction

Read this User Guide carefully and thoroughly before operating the Nova3D ELFIN for the first time. The User Guide includes basic information about the 3D printer, safety and protection guidelines as well as advice on preparing the machine for the first printing process and basic maintenance work. Ignorance and non-compliance with these instructions may result in property damage, injuries, device failures. It is also necessary to ensure that every 3D printer user knows, fully understands and follows the instructions provided in this User Guide.

The Manufacturer makes every effort to ensure that Nova3D products are safe in transportation, installation, usage, storage and disposal. However, due to the lack of direct and ad hoc control as well as other conditions influencing the device and those that are beyond the Manufacturer's knowledge, the Manufacturer is not responsible for damage, injuries, failures and costs resulting from improper transportation, installation, usage, storage and disposal. Furthermore, the users should take into consideration the risk of possible damage of the device resulting from defects in material and workmanship.

The users are responsible for qualifying and determining the intended use of 3D printed models. The Manufacturer takes no responsibility for any use of printed objects, especially when those objects constitute a part of safety devices or strictly regulated by specific rules medical, military or space science equipment.

All products, technical specifications and data are subject to change without notice due to improved reliability, functionality, design or other reasons. Shenzhen Nova Robot Technology Co., Ltd. (Nova3D), its agents, the employees and all individuals representing the company take no responsibility for any errors, inaccuracies or incompleteness in any product-related data manual or other published information.

Due to the size and specificity, the Nova3D ELFIN is not intended for use by minors and by people with reduced manual, motor and psychomotor skills. The Manufacturer recommends providing assistance and guidance to people with disabilities who wish to operate the printer.

Nova3D makes no guarantee, statement or warranty as to the applicability of products

for the specific purpose or the continuous production of any product. Within the sphere permitted by law, Nova3D does not assume (I) the responsibility for any consequences arising from the use any product;(II)the responsibility for including but not limited to specific, joint or collateral damage ;And (III) Nova3D don't do any implied warranty, including not guarantee of the applicability , non-infringement and merchantability of the specific use .

No license, express or implied, by estoppel or otherwise, to any intellectual property rights is granted by this document or any act of Nova3D. All trade names, logos and trademarks mentioned in the following document are registered trademarks of Nova and are subject to legal protection.

## General Safety Information

This User Guide contains important safety directions that should be followed during installation and operation of the Nova3D ELFIN. It also mentions situations which require special attention and includes warnings against negligence and misuse that could cause damage or injuries.

Always read the safety data sheets available at:

<http://www.nova3dprinter.com/material.html>. There are a source of basic information and safety procedures for the materials you bought. It is essential to regularly update the firmware to avoid any kind of failures.

Visit our website: <http://www.nova3dprinter.com/> to learn about the latest news and updates.

Printing process with the Nova3D ELFIN requires using liquid photosensitive resin which in a liquid form is toxic and may cause allergic reactions. Therefore, you must protect your skin and eyes when using the printer by wearing safety gloves and glasses. Provide proper ventilation in the print room.

It is also extremely important to avoid spilling the resin on the printer and its surroundings

while operating the printer, filling the vat and removing prints from the platform. Ensure that the printer is level and keep it on a stable surface. Do not remove the UV cover during the printing process.

Do not leave the machine unattended during the printing process, check it periodically for proper functioning in order to avoid potential accidents or breakdowns. Turn off the printer and empty the resin vat once the printing process is finished.

Keep the printer away from heat sources, flammable materials, equipment emitting radiation, sources of fire, humidity, water and other liquids. To prevent any inadvertent use, keep the device out of reach of children and animals. It is forbidden to drop or shake the printer as it may cause breakdowns. The equipment is not intended for use in a potentially explosive environment.

The Manufacturer strongly recommends setting up a special room dedicated only to 3D printing. The room should be as free of daylight as possible and properly ventilated. It is important to avoid situations in which liquid resin is exposed to daylight.

## **Workplace Health and Safety**

Keep the workplace clean. Containers with resin should be tightly closed and kept in a dark place. The device should be configured according to its intended purpose. Improper configuration may cause defective operation which may lead to damage of the device. Food and beverages should be kept away from both the 3D printer and the 3D printed objects. Do not put any objects under the UV cover. While operating the Nova3D ELFIN, all measures regarding health and safety that are provided in this User Guide as well as in separate regulations should be taken into account.

## **Electrical Safety**

Nova 3D printers have been tested for compliance with Low Voltage Directive. In order to ensure the highest safety standards, including protection against short circuit, overload, overvoltage and printer overheating, do not attempt to modify the printer and do not use electronic replacement parts other than those recommended by the Manufacturer.

Replace electronic units according to the instructions and be particularly careful while using the tools supplied with the printer. Before plugging the power cable into the outlet, make sure that the power supply voltage in the outlet matches the required value provided on the nameplate at the back of the printer.

Avoid overloading the outlet with too many devices. The printer must be well-grounded. Always make sure that the ground complies with local and national regulations. Do not expose the device to rain and humidity. While filling the vat with resin, be careful not to spill the resin outside the vat. Liquid that enters the inside of the device increases the risk of an electric shock. All maintenance and repair work should be carried out while the device is off and unplugged. Modifications such as soldering of electronic subunits are forbidden.

## **Mechanical Safety**

The Nova3D ELFIN has movable components, such as the build platform and the Z-axis. Therefore, it is forbidden to reach into the printer or put anything inside the printer when it is running, about to start running or at rest. Tools and accessories delivered with the printer should be used with special care. Improper use may cause serious injuries. While following post-processing procedures, wear safety gloves and glasses to avoid injuries that may be caused by sharp edges and fragile elements of models. A finished print must be removed from the platform outside the printer, after both the platform and the model have been cleaned from uncured resin in a liquid detergent. To avoid injuries, be particularly careful while removing prints from the platform. Always wear gloves and glasses. The FEP film that is installed in the resin vat is very thin and fragile, therefore, special care should be taken when cleaning, installing and disassembling the vat.

## **Risk of Burns**

There is no risk of burns as all components working in high temperatures are enclosed, but don't touch the inside parts. Constructional modifications of the printer's operating temperature are not permitted as it may cause serious injuries or bring damage to the device. Nova3D devices must be stored between 18 and 35° C [64 - 95° F]. The storage space should

be free of moisture and other extreme conditions.

## **Transport Instructions:**

When stacking several devices on a pallet, follow the instructions provided on the packaging. Once device may weigh more than 10 kg [22 lb]. It is therefore advisable to provide safe pallet storage but not higher than 1.7 m [5'7"']. It should be noted that the packages must not project beyond the outline of the pallet. Packages stacked on the pallet should be then bound together and wrapped in foil. The pallet prepared as above can be then forwarded to the shipping company.

Pallet stacking and destacking should be carried out by two people. The package with the device should be lifted or moved using special handles.

## **Electromagnetic Compatibility (EMC)**

Nova3D printer complies with Part 15 of the FCC rules. Its operation is subject to the following two conditions: this device may not cause harmful interference, and this device must accept any interference received, including interference that may cause undesired operation.

The printer generates, uses, and can radiate radio frequency energy and, if not installed and used in accordance with the following User Guide, may cause harmful interference to radio communications. Operation of this device in a residential area is likely to cause harmful interference, in which case the user will be required to eliminate the interference at his own expense.

## 1. Learn More About the Nova3D ELFIN















Nova3D ELFIN is a 3D printer which, together with NovaMake and dedicated materials, constitutes the whole 3D printing ecosystem. This device makes it possible to turn digital, three-dimensional projects into reality using the UV LCD technology which relies on curing liquid photopolymer layer after layer. The UV LCD technology involves projecting an image of a layer on the transparent underside of the vat with liquid resin and curing the layer using backlight from a UV lamp. After each layer is cured, the lamp pauses to operate. During the pause, the layer solidifies and the platform rises and lowers itself so the resin is equally distributed in the vat. The printer is equipped with an LCD screen which is responsible for projecting successive layers and masking the UV light. Thanks to that, the resin that is outside the image of a layer is not cured and can be used to print the rest of the model. The printer allows users to print multiple parts at the same time without affecting the accuracy and printing speed. Once the printing process is finished, the model has to be post-processed in two steps. The first step involves cleaning the print from residues of uncured resin in a liquid detergent, whereas the second step involves additional UV curing so that the object acquires its intended properties. The Nova3D ELFIN can be used for creating prototypes and concept models in engineering, as well as for creative applications, such as figurines and gadgets.

Everything begins with preparing a model. The work on the project can start in any program which creates 3D models and generates .stl, .obj files. These are the standard file formats supported by most types of modeling software - the model is saved as a set of three-dimensional triangles (triangle mesh). The next step is to open the .stl file (or .obj, .nmk files) in NovaMake - the program created specifically for Nova3D devices. NovaMake prepares the model by slicing it into individual layers and saving it as a .cws file. NovaMake also allows you to choose the material type to be used for the model and to adjust the necessary print settings, such as layer thickness, layer exposure time, exposure off time or how many support structures should be generated. The file is then ready to be printed.

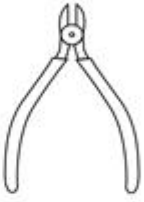

To start the printing process, turn on the printer, prepare the material which corresponds with the one you have chosen in NovaMake and carefully fill up the vat with an appropriate amount of liquid resin. While working with the Nova3D ELFIN, you can start, stop and pause the printing process in NovaMake. Once your file is prepared, you can transfer it from NovaMake to the printer's storage in two ways. You can either save the file on a USB flash drive and plug it into the port at the back of the device or transfer the file from NovaMake over Wi-Fi / Ethernet cable. In addition, NovaMake allows you to add several printers to the panel and create a network of devices. This solution makes it possible to produce 3D models in a small series and manage the whole process from the screen of your computer. Each printer can still be operated using the touch screen at the front. It is also possible to change all settings related to exposure time of particular elements of the model directly during the printing process.

## 2. What's in the Box

 <p>ELFIN x1</p>	 <p>Platform x1</p>		
 <p>Funnel x1</p>	 <p>Filter x2</p>	 <p>Gloves x4</p>	 <p>Power Cable x1</p>
 <p>USB Flash Drive x1</p>	 <p>Spatula x1</p>	 <p>Plier x1</p>	 <p>Spray Bottle x1</p>
 <p>Spare Screws x13</p>	 <p>Hex Wrench x3</p>	 <p>FEP Film Set x1</p>	 <p>Resin Vat x1</p>

## Use of Tools

**Platform:** The model is adhered to the platform during the printing process.

**Resin Vat:** A container for resin material.

**Power Cable:** connect to the power supply.

**Funnel:** A tool for recycling resin materials.

**Filter :** Filter the cured remains in the used resin.

**Gloves:** Protect hands from injury.

**USB Flash Drive:** Built-in NovaMake software, e-manual, quick guide, model file, etc.

**Spatula:** Use to check if there are residues of cured resin in the vat before each printing process.

**Pliers:** Use to cut off the model support.

**Spray Bottle:** Spray alcohol to clean the residual resin on the model.

**Spare Screws:** Spare screws for securing FEP film, LCD screen and device base.

**Hex Wrench:** The disassembling tool for maintenance and replacement of parts.

**FEP Film:** A film installed at the bottom of the vat to separate the model.

### 3. Main Components

#### Front View

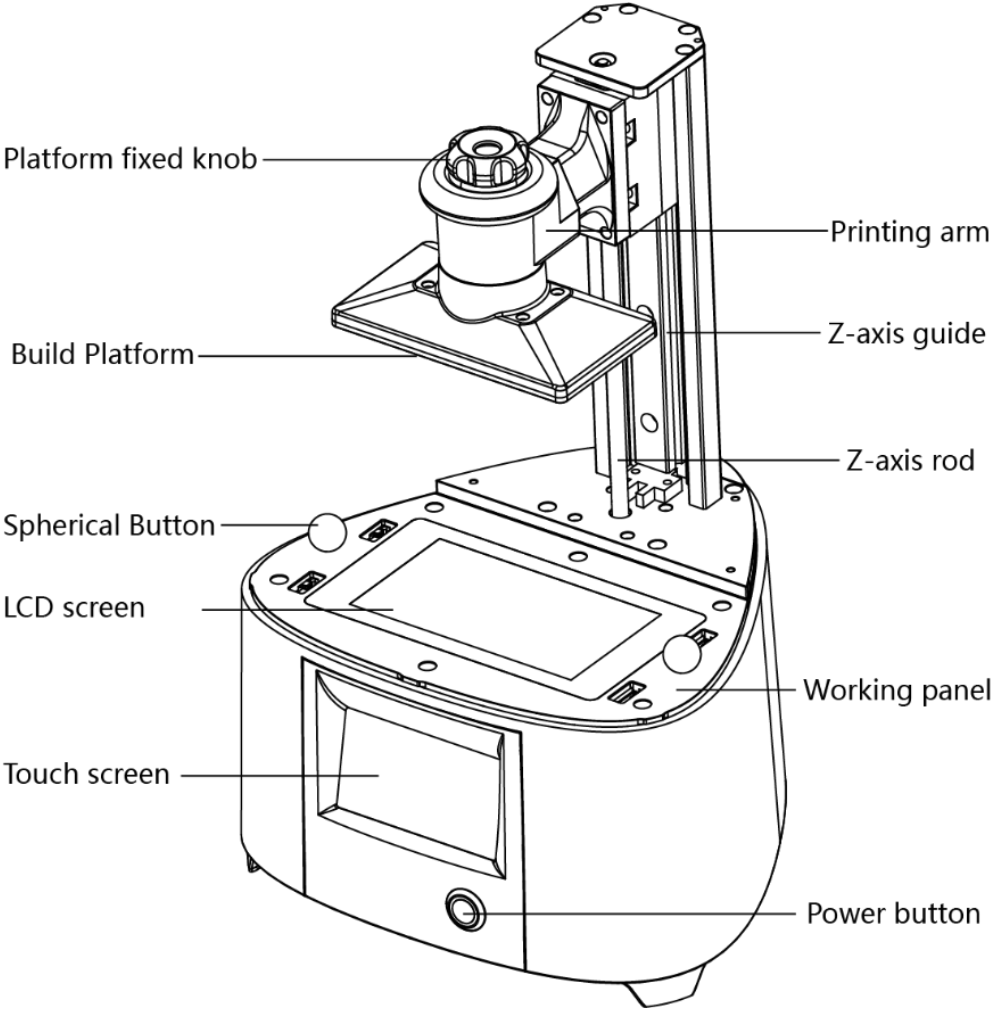

Schematic diagram of the front of the device

## Back view

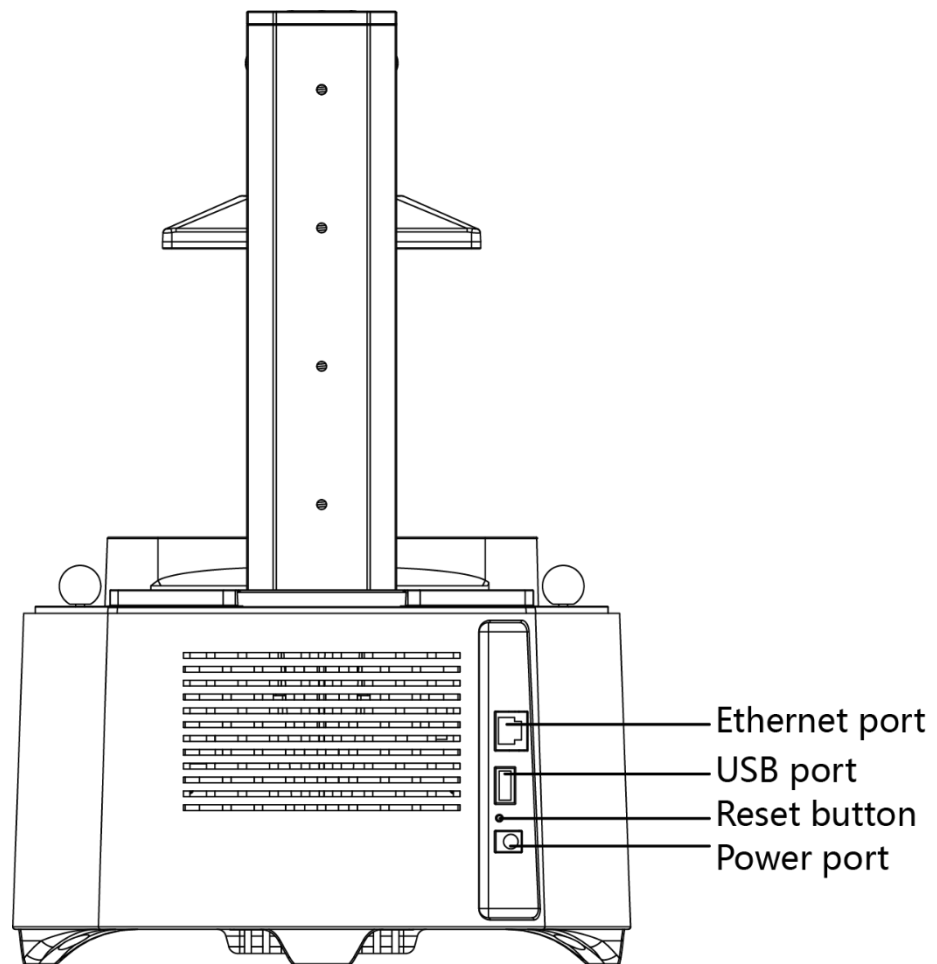

Schematic diagram of the back of the device

## 4. Nova3D Printing Technology Glossary

### **Nova3D Technology**

A technology which relies on curing photopolymers layer after layer. The UV LCD technology involves projecting images of successive layers on the underside of the vat with liquid resin and curing them using backlight from a UV lamp.

### **NovaMake**

NovaMake is an app developed by Nova3D, it prepares a model for 3D printing by generating the file in the .CWS format. NovaMake allows the users to change and adjust the print settings, such as the size of the model, layer thickness, or how many support structures will be generated. The last step is to transfer the file to the printer's storage over Wi-Fi /Ethernet cable or by using a USB flash drive.

### **Firmware**

The software programmed into Nova3D printers, which controls and monitors all the data in the device.

### **FEP Film**

A transparent foil which is installed in the rack attached to the resin vat. It creates a clean way for the UV light to quickly and precisely cure liquid resin during the whole printing process. The FEP film requires replacement once it becomes stretched or deformed.

### **LCD Screen**

The flat-panel display essential for 3D printing in the UV LCD technology. It is

responsible for projecting images of layers on the underside of the resin vat during the whole printing process. It also masks the UV light so that the resin that is outside the image of a layer is not cured and can be used to print the rest of the model.

## **Platform**

An integral part of the printer, to which models adhere during the polymerization of resin. Also, it rises and lowers itself during the printing process so that each layer can solidify and the resin can be equally distributed in the vat. The platform is made of anodized aluminum which facilitates high adhesion of models. It can easily be removed or installed back in place.

## **Resin Vat**

The container in which liquid resin is kept throughout the entire printing process. It consists of ABS+ glass fiber frame and a rack with FEP film. The resin vat is secured to the printer's housing directly on the LCD screen with two spherical buttons.

## **Post-processing Kit**

Several pieces of equipment that are put together in one set and delivered with the printer. The set contains tools and protective equipment including, for example, hex wrench, funnels and spatulas. The tools from the post-processing kit are required for operating the printer as well as for performing maintenance work.

## **Touch Screen**

The display screen placed at the front of the printer, which enables fast and intuitive navigation through the device's menu. The screen also displays information about the current printing process and other information concerning the printer.

## UV Cover

The cover placed on top of the printer responsible for protecting liquid resin from ambient UV light. It also helps to keep unpleasant smells of resin inside the printing chamber.

## Support Structure

Special 3D printed structures in the form of pillars which ensure that the whole model adheres to the platform and doesn't fall into the resin vat during the printing process. Supports are printed with the same material as the model. Once the printing is done, supports have to be removed from the model by hand or using pliers.



## 5. First Use Preparations

1. Open the box and remove the upper cushioning.

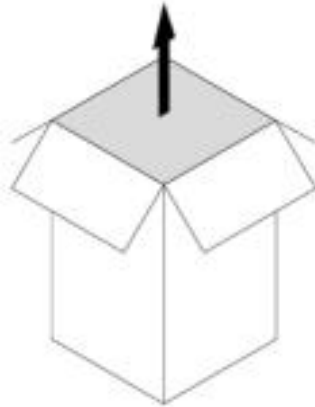

2. Remove the UV cover.
3. Take the printer out of the box.

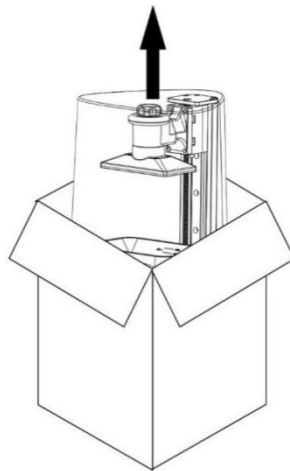

4. Place the printer on a flat and stable desktop and ensure that the desktop is flat and not shaking.

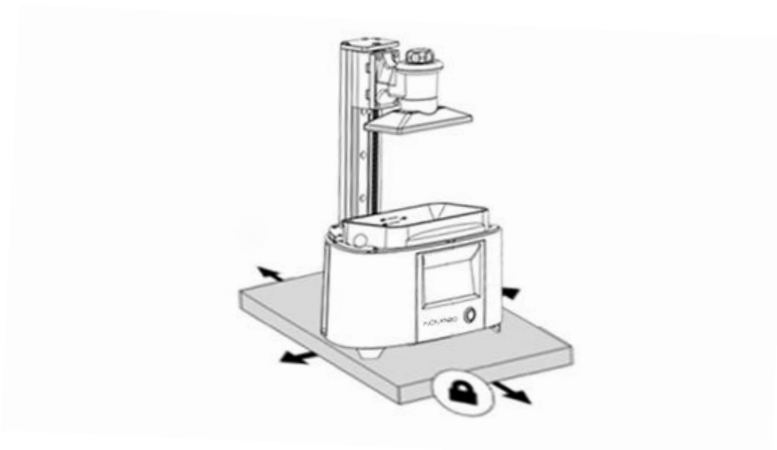

5. Clean the FEP film and the LCD screen with a cloth.

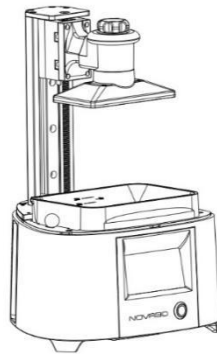

6. Plug in the power adapter and press the front panel power to turn on the printer. Connect it to a network via Wi-Fi or Ethernet. Go to *Settings* and configure the connection using options from the menu.

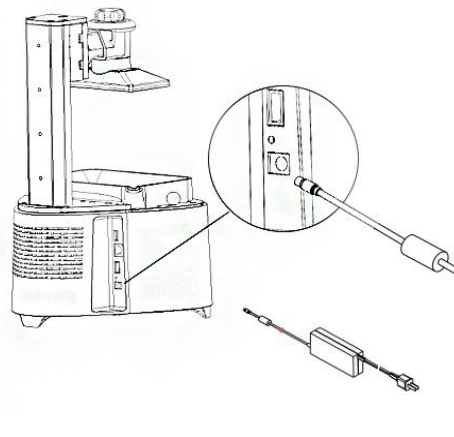

7. Select the "Network Settings" menu in "Settings" of the machine control menu, and set WiFi connection according to the network settings; Make sure the printer is properly connected to the network. After setting up (a string of address information is displayed at the current IP address), the device is ready to print.

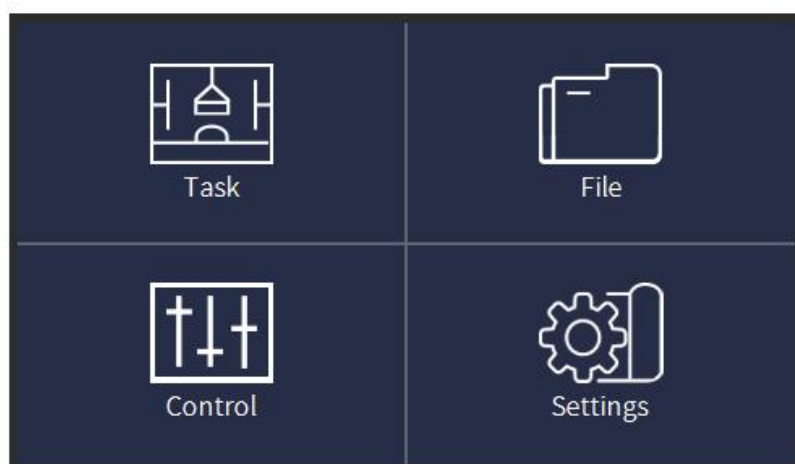

## 6. Connecting the Printer to a Network

Nova3D ELFIN can be connected to a local network in two ways: via Wi-Fi or an Ethernet cable. Both methods allow you to manage the printer directly from NovaMake and make it possible to remotely transfer .cws files from your computer to the printer.

### To connect the printer with an Ethernet cable:

Plug the cable to the port of the device and plug the other end of the cable to the network interface of the computer or network adapter . Open NovaMake software, click the icon on the right side of the title bar  to enter the printer management interface, then click the "+" on the upper right side to display the pop-up box of "printer add guidelines", select the first item (the printer has not done network configuration...) and then proceed until prompted to add the printer successfully.

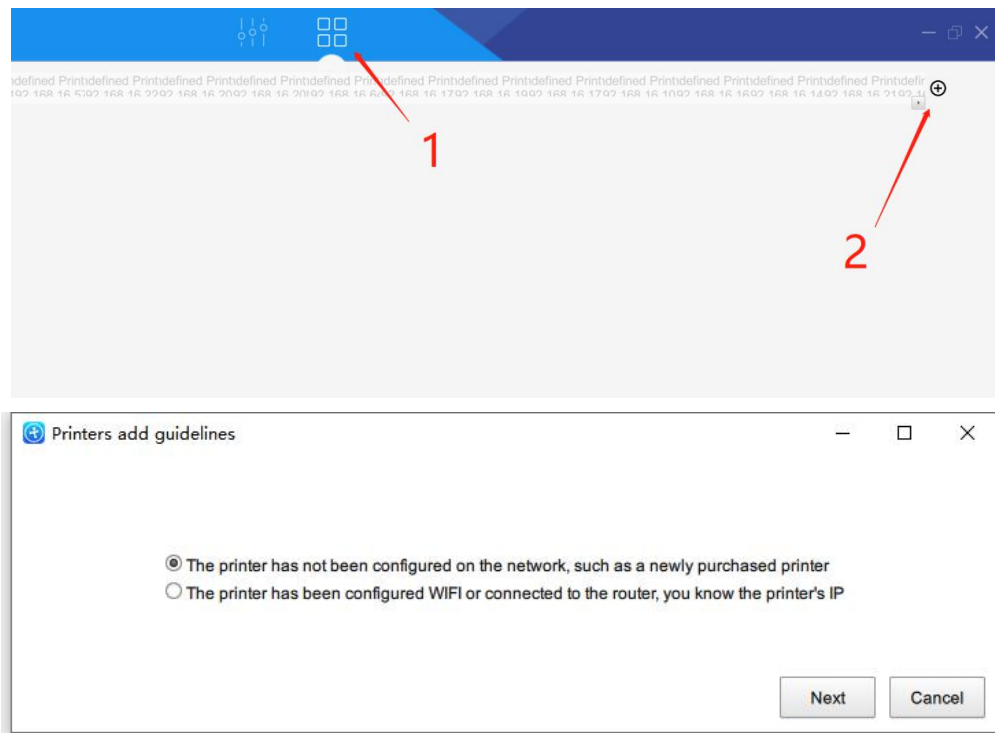

## To connect the printer to a Wi-Fi network

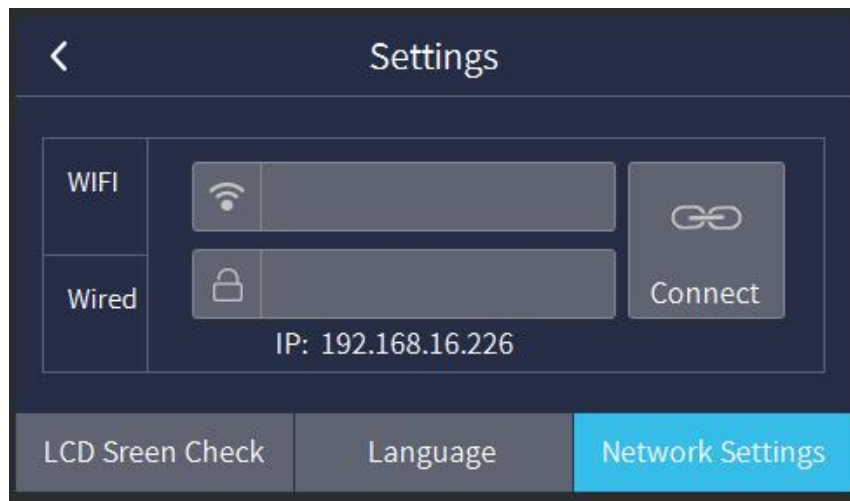

After setting WiFi connection in "Network Settings" on the device, enter the printer management interface on the computer according to the current IP address. Click "+" to pop up "printer add guidelines" and select the second item (the printer has been configured with WiFi...) as shown in the figure, next input the current IP address and then until the wireless addition is successful.

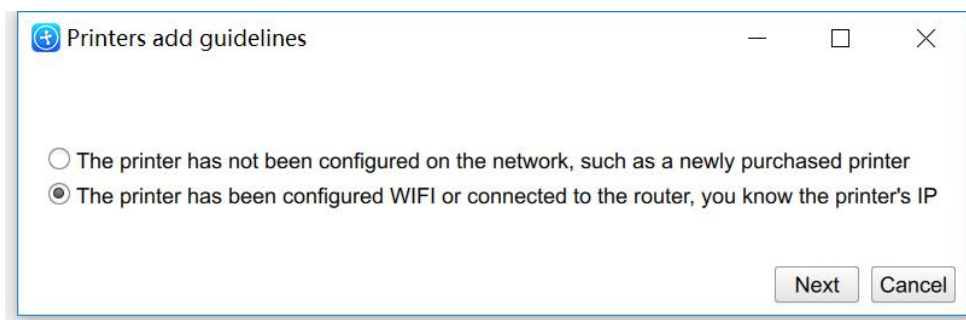

Once your printer is connected to the network, open the *My Devices* panel in NovaMake. You can search for devices available in the local network and add them to the program's panel. Select the icon with your printer's IP address and click on it to go to the selected printer details page.

Each added printer can easily be managed in NovaMake. You can start, stop and pause the printing process, see the printer's current state (*Ready to Print / Printing / Paused / Offline*), change the name of your printer, or preview basic information about the printer.

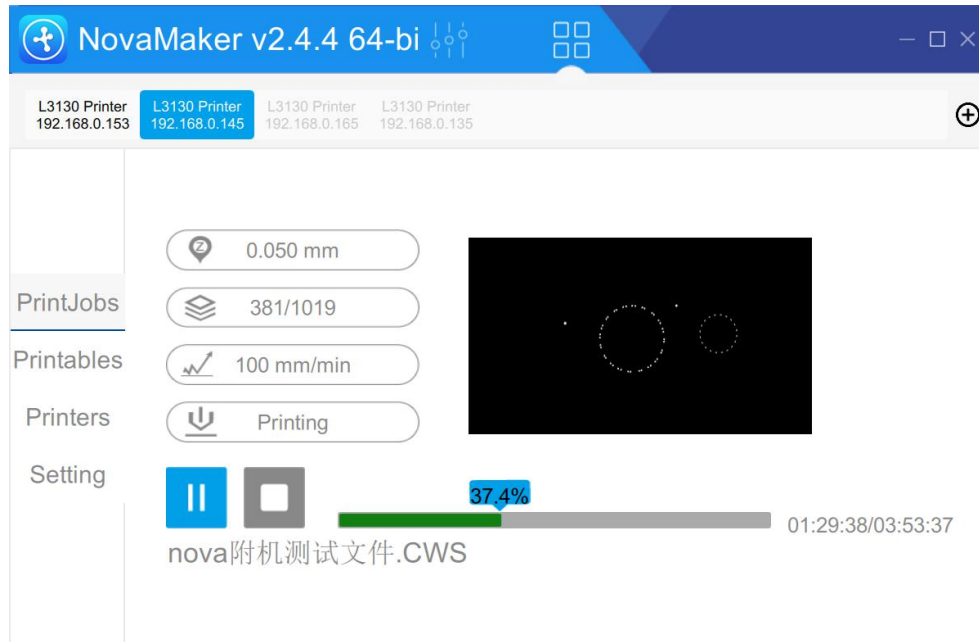

## 7. Firmware Update

If your printer is connected to the Internet using either Wi-Fi or an Ethernet cable, it automatically checks for available firmware updates and starts the installation process. You can also manually check whether there is an updated firmware version. After opening the NovaMake software, select system Settings -> upgrade -> check the version. If there is a new version, there will be a prompt of "click upgrade". (as shown below)

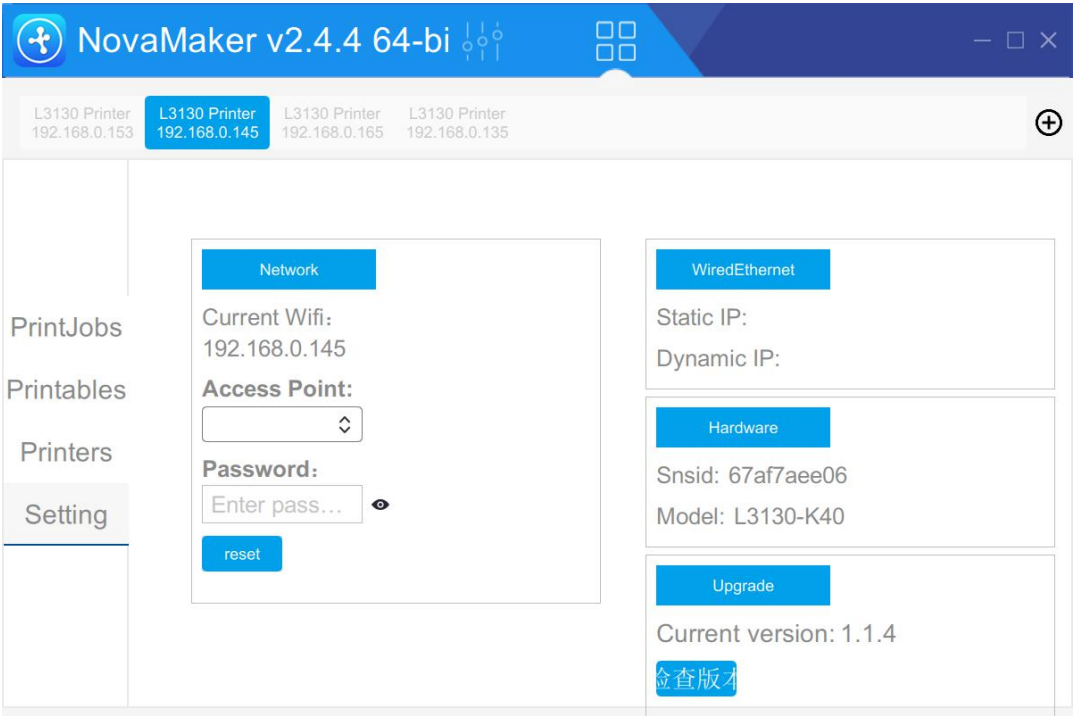

## 8. Navigating Through the Menu

The main menu is divided into four icon corresponding functions: Task, File, Control and Settings.

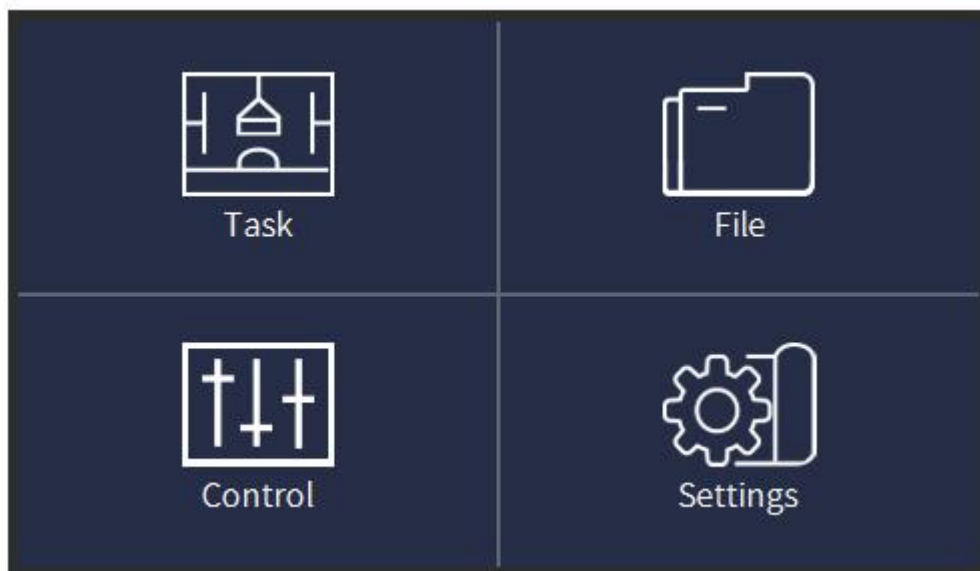

### ➤ Task

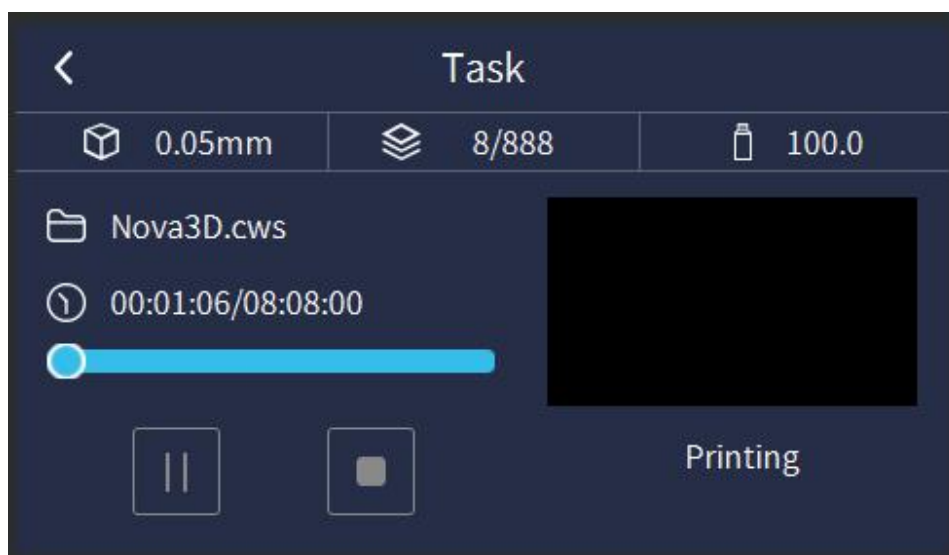

1. Print details: layer thickness of model slices , current layers of printing and total layers of slices, estimated amount of resin consumed for printing, file name, printing progress (including completed time and total time) and current printed picture.
2. Control: Pause, Start, and Stop functions.

➤ **File**

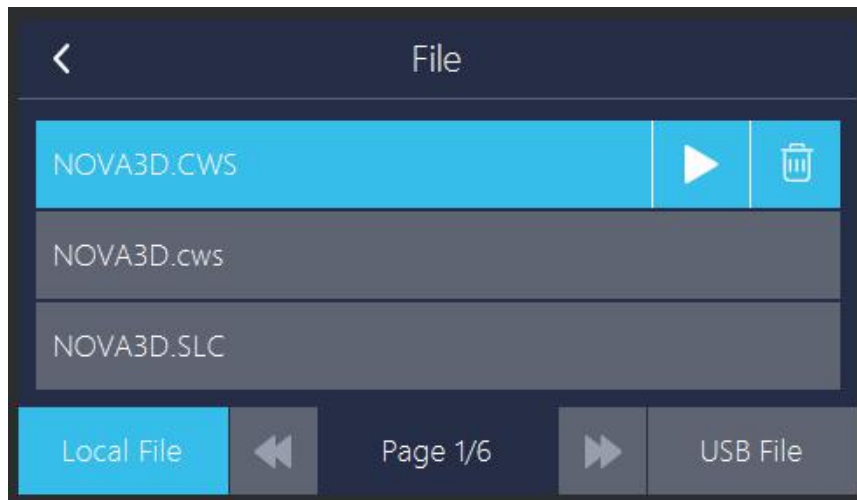

Display the list of all files in the internal memory of the device and the external USB drive .  
You can select files here and then print and delete them.

➤ **Control**

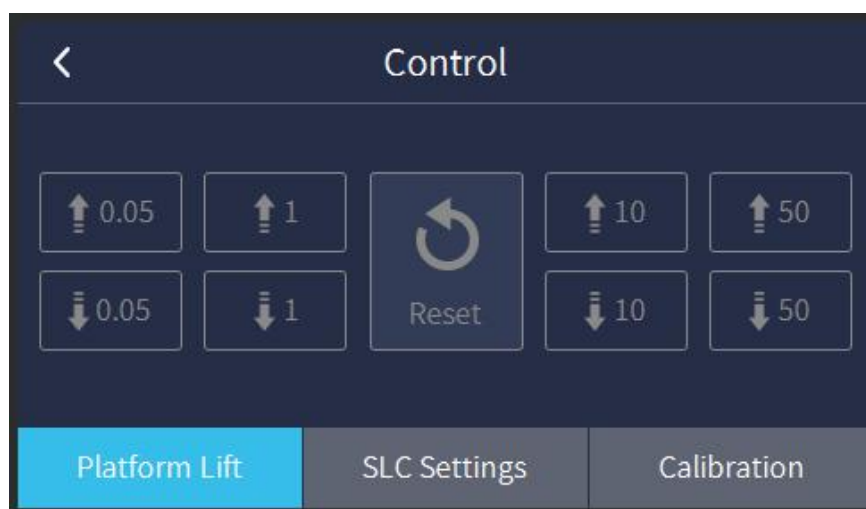

1. Platform lift: manually control the platform up and down.
2. SLC Settings: Printing settings for SLC files output from JewelCAD slices (including: bottom layers, bottom layers exposure time and normal exposure time)
3. Calibration: fine-tune the original starting point of the platform.



➤ **Settings**

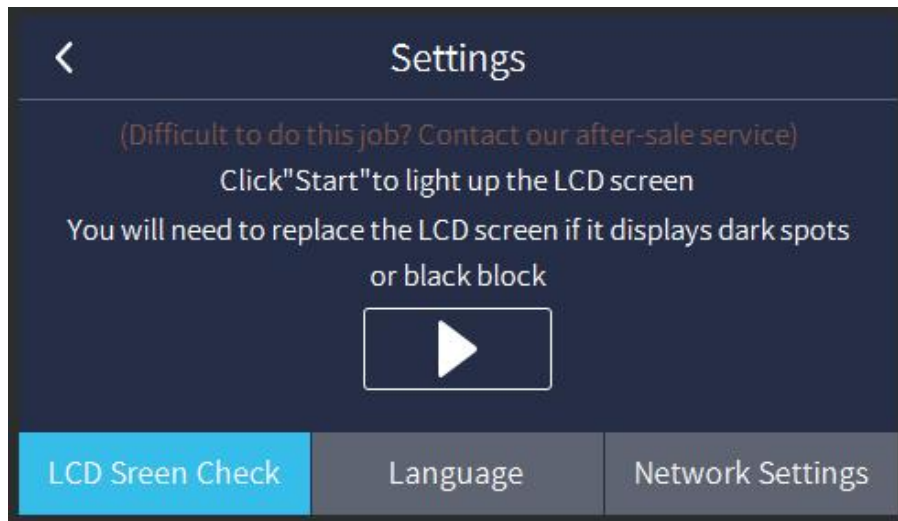

1. LCD screen check: check the LCD screen for proper operation
2. Language setting: set language of the device.
3. Network Settings: set up the printer to the network connections (including WIFI and the wired network connections)

## 9. NovaMake Software

Download and install NovaMake software on Nova3D website at: <http://www.nova3dprinter.com>, enter the "Software" page of "Support" as shown in the figure, download the version installation package with corresponding digits of the computer, and then install NovaMake.

For details of software operation, please refer to NovaMake software User Guide. We provide the most comprehensive and detailed software instruction to help you get started quickly.

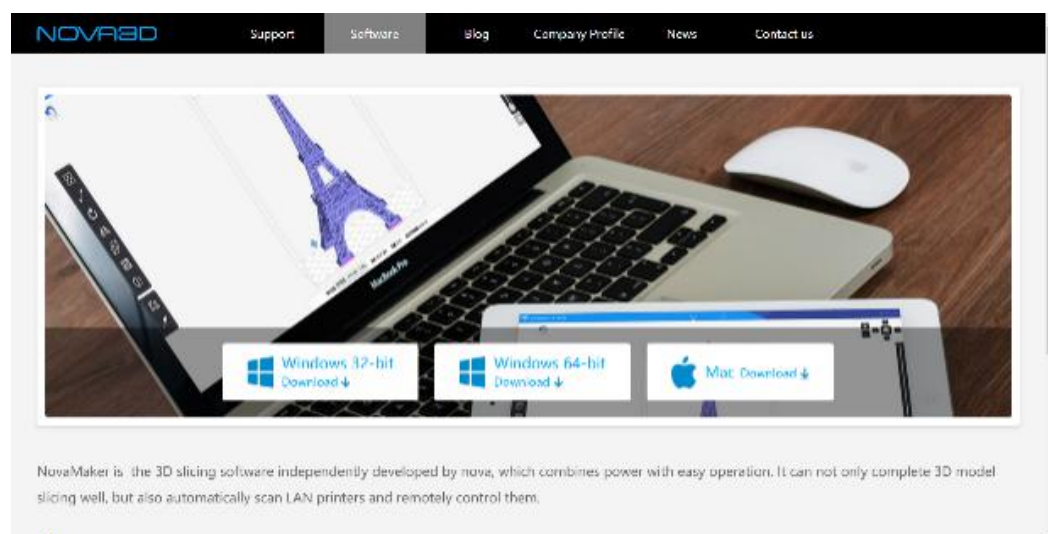
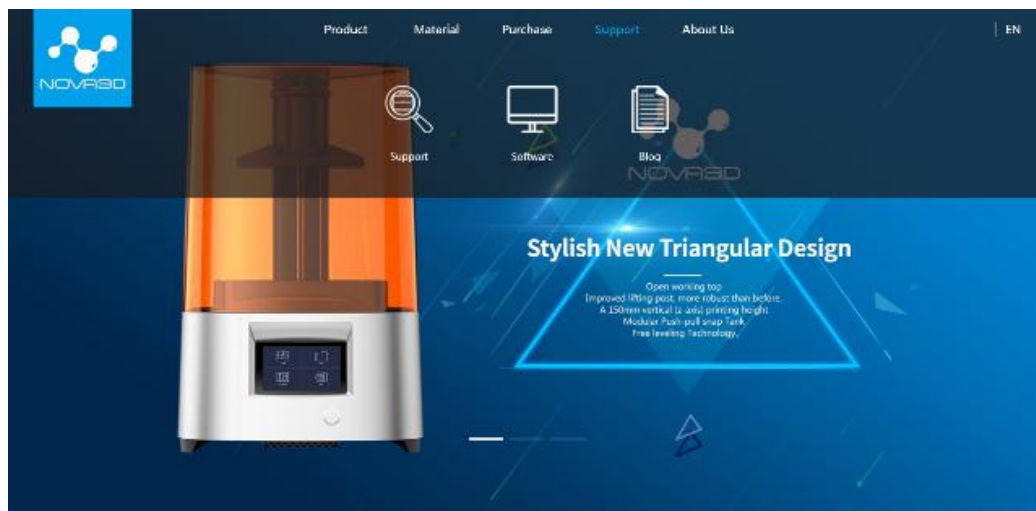

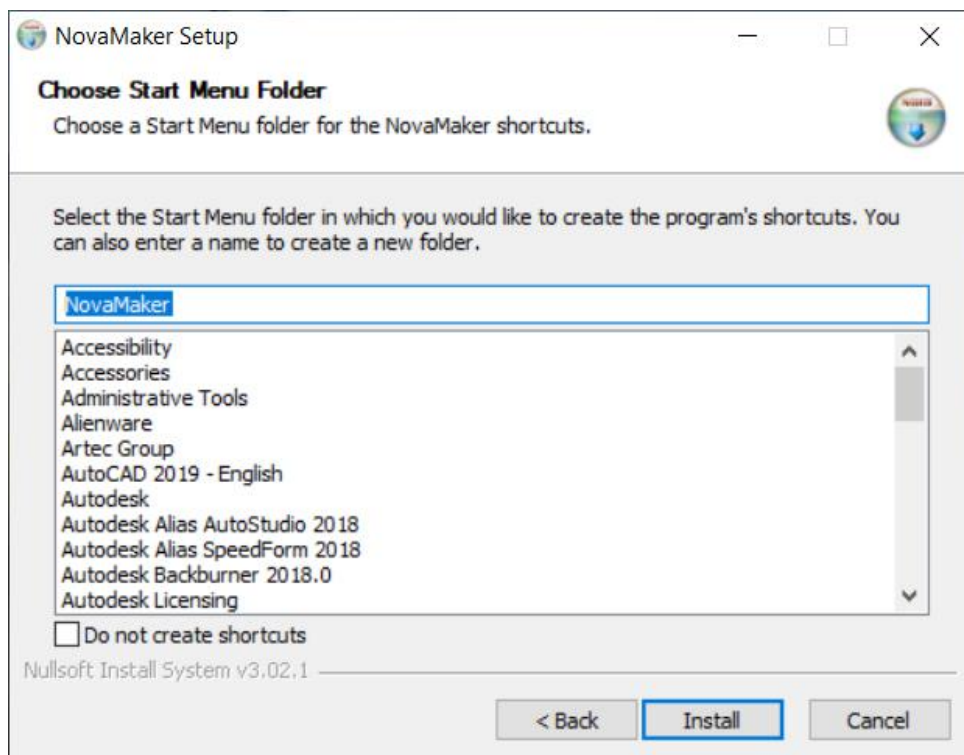
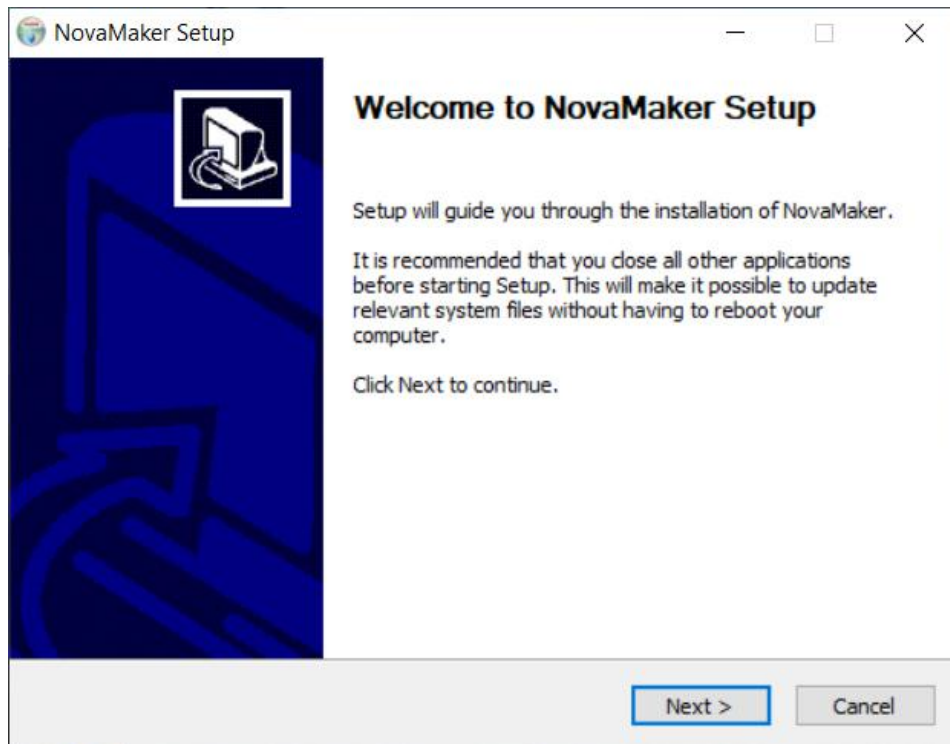

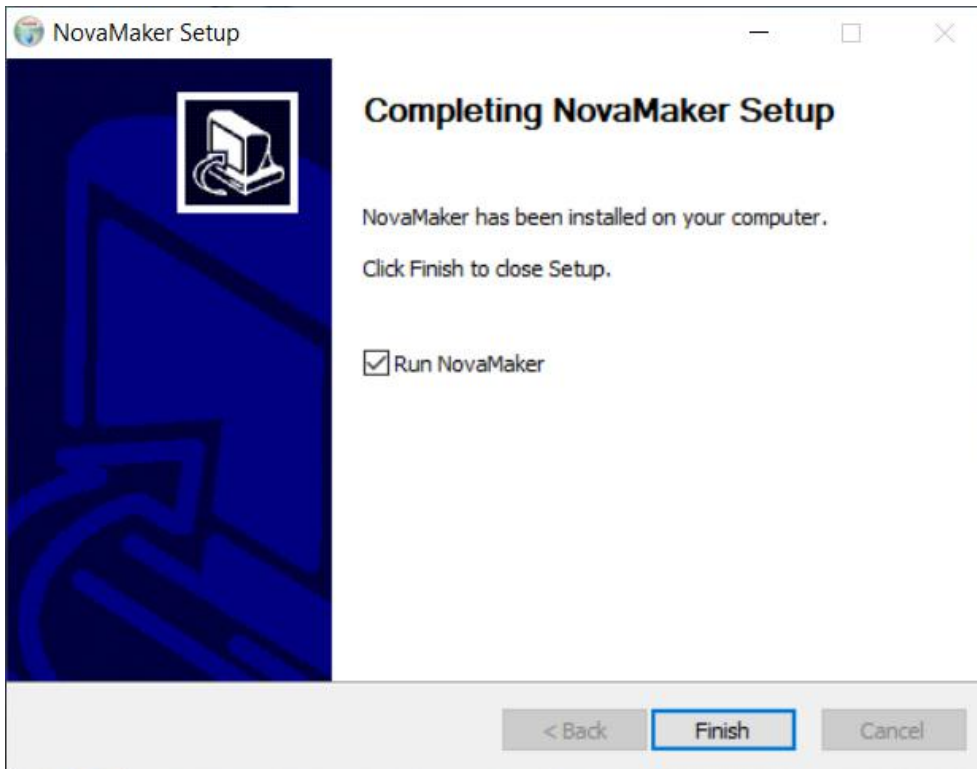
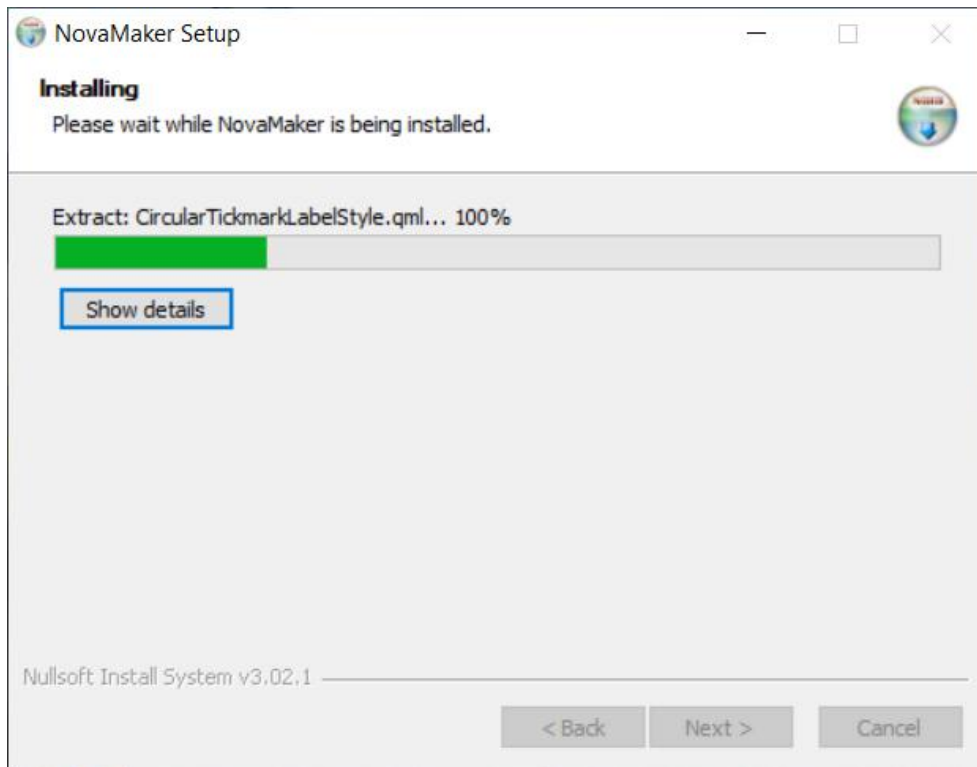

## 1. User Interface

The software has 3 major functional sections: 3D Slice, Printer Control and 3D Views Control.

The 3D slice function can move, scale, copy, place and slice 3D model files. The printer control function is to manage the printing devices, modify the connected device parameters, upload the slice file, etc. The views control function can check the view of each direction of the model and the internal view of the model cut surface.

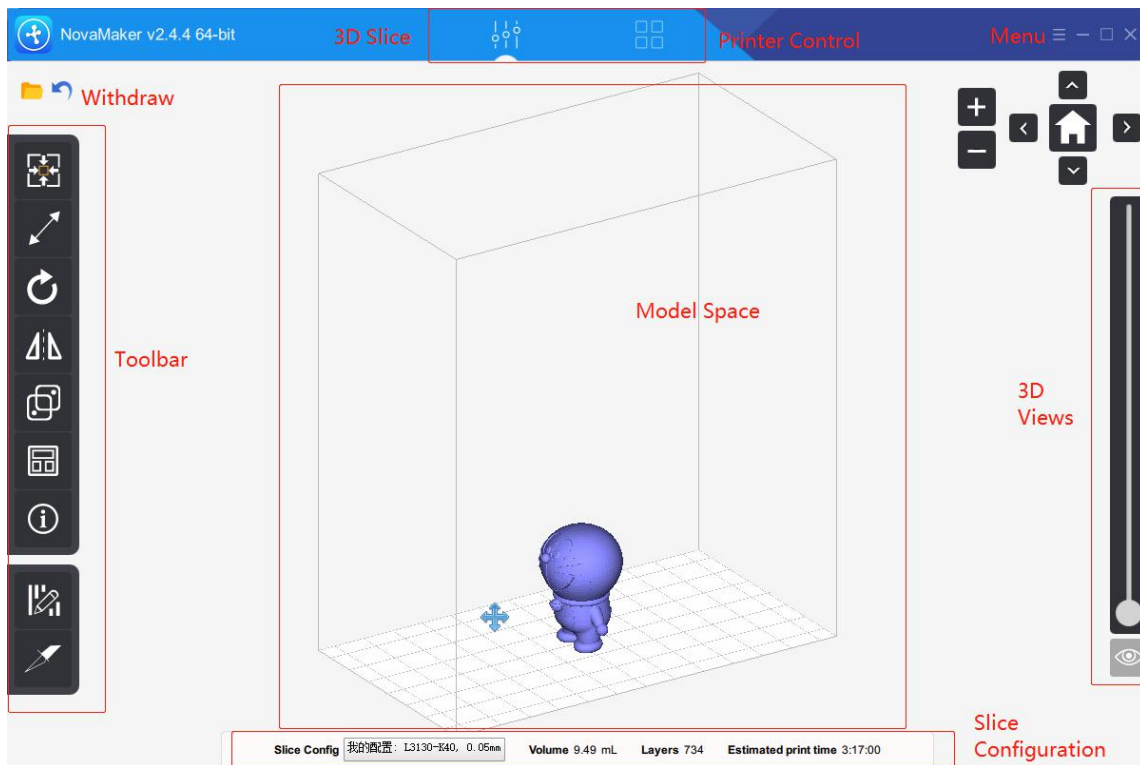

### 1.1. 3D Slice

The main function of 3D slice is concentrated on the left side of the software, display of the model can be adjusted by mouse:

Drag the left mouse button: rotate the view

Drag the right mouse button: move the view

Rolling mouse wheel: zoom the view

After selecting the model with the left button, the toolbar on the left side of the software will be brightened. Function of each icon is as follows:

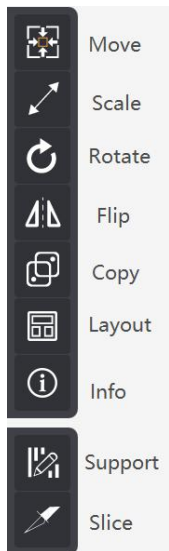

**Move:** Place the model at a reasonable position on the platform

**Scale:** Scale up or down the model volume

**Rotate:** Rotate the model in X, Y, Z directions

**Flip:** Flip the model according to the X, Y, Z axis

**Copy:** Copy the selected model

**Layout:** Automatically place the model at a reasonable platform position

**Info:** View the size and volume of the model

**Support:** Add support to the model

**Slice:** Slice the model file and upload it for printing

## 1.2. Printer Control

Printer Control includes: PrintJobs, Printables, Printers, Setting.

### 3.2.1. PrintJobs

1. Layer thickness (default: 0.05mm)
2. Slice status (current completed layers/total layers)
3. Motor speed (mm/min)
4. Printing status (printing)
5. Pause (pause printing task)
6. Stop (stop current printing task)
7. Progress bar (displays the percentage of printing progress)
8. Current printing file name (print file name)
9. Current printing status

## 10. Currently printed image (real-time display current slice interface)

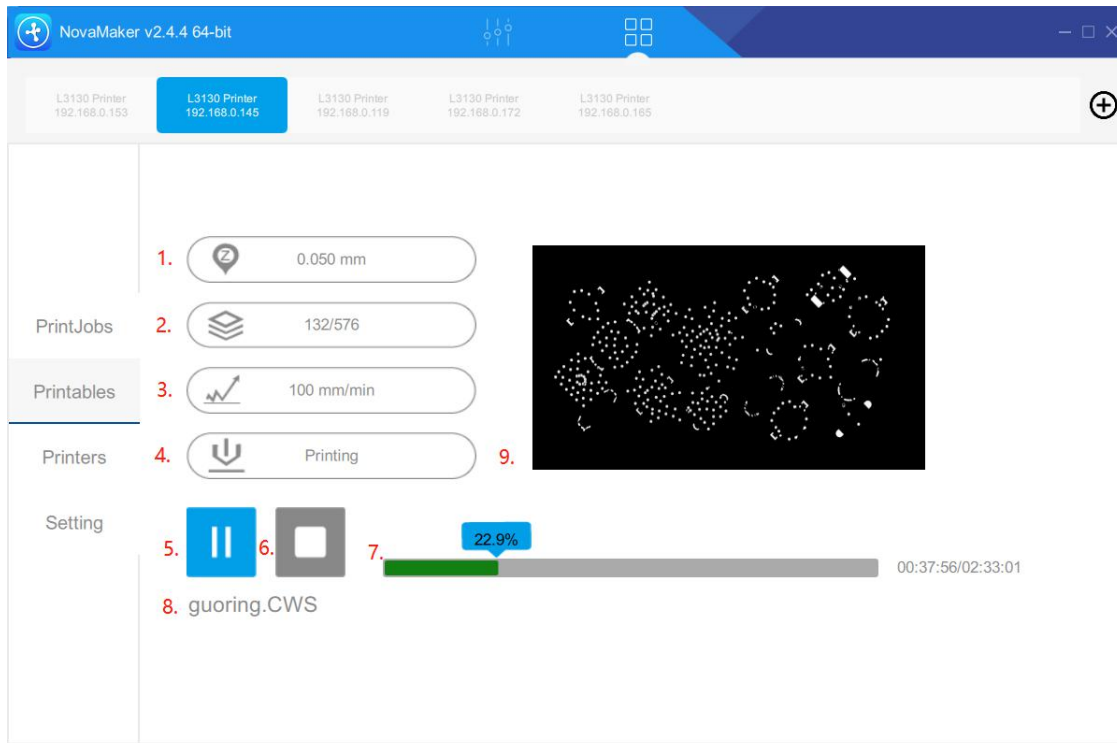

### 1.2.2. Printables

1. Print: to print current selected .cws file
2. Delete: to delete the .cws file stored in the printer
3. Upload: to upload the file to print
4. List of files stored in the printer

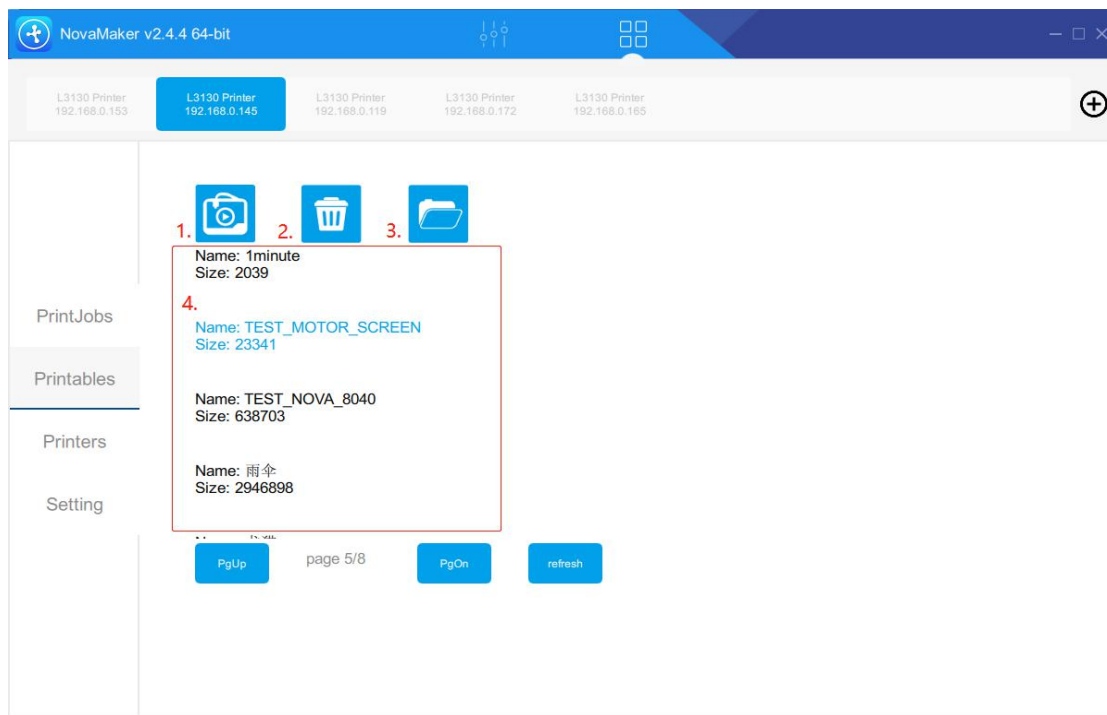

### 1.2.3. Printers

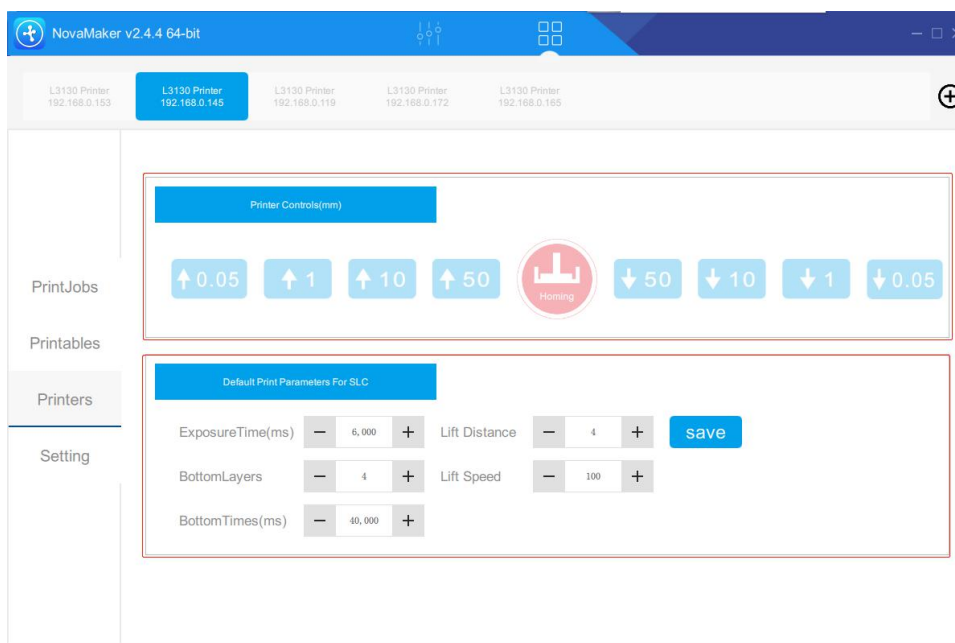

(1) **Printer Control:** controls the lift and decrease as well as reset of the platform.

The platform can be moved at a distance of 0.05, 1, 10, 50mm, the user can adjust the position of the platform according to the actual situation.



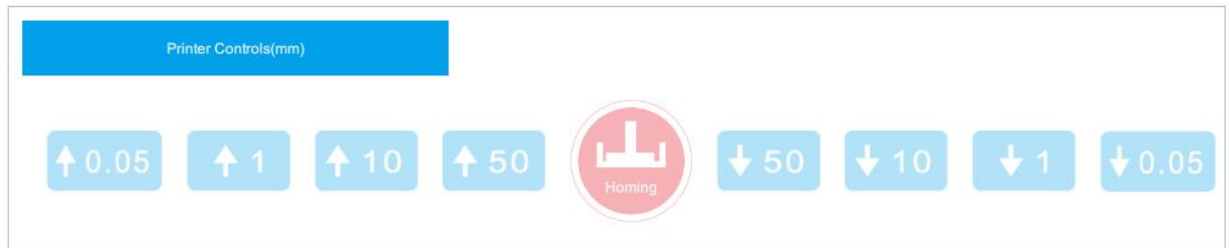

(2) **Default Print Parameters for SLC:** When printing with a .cws file, the parameters are generally defaulted and do not need to be changed. If you need to adjust the parameters, please contact Nova3D after-sales engineers for technical support.

**Exposure Time (ms):** set the exposure time of each layer

**Bottom Layers:** set the number of bottom layers

**Bottom Time (ms):** set the exposure time of bottom layers

**Lift Distance (cm):** control the lift distance of the platform after a layer is printed

**Lift Speed (mm/min):** control the lift speed of the platform

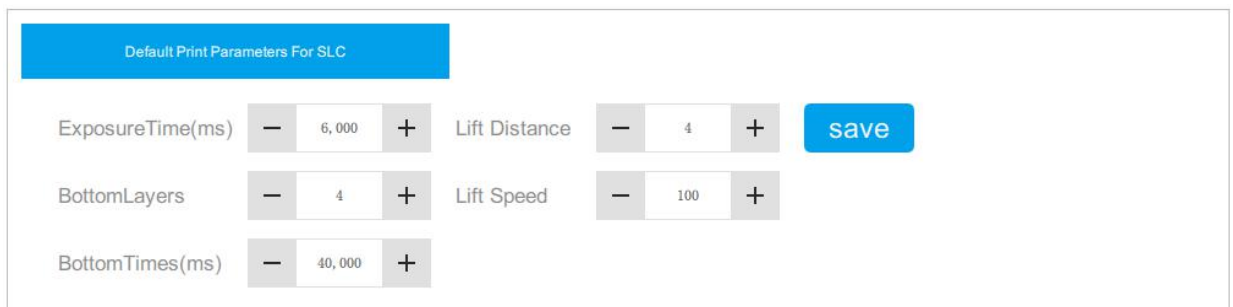

#### 1.2.4. Setting

Users can read printer information including: WiFi network configuration, wired ethernet IP, hardware information, upgrades, etc.

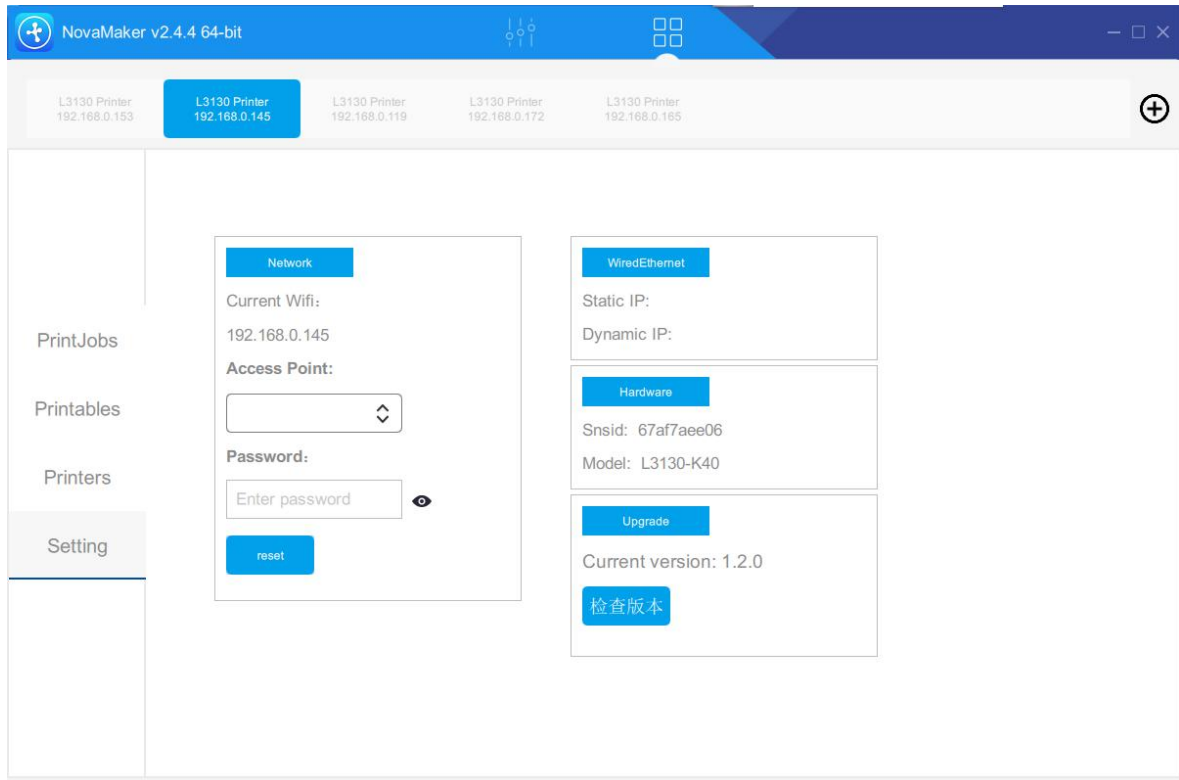

### 1.3. Views Control

The views control menu at the upper right corner of the software corresponds to the switching and scaling of the view. Including: left view, right view, bottom view, top view, front view.

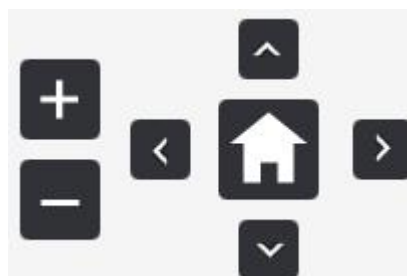

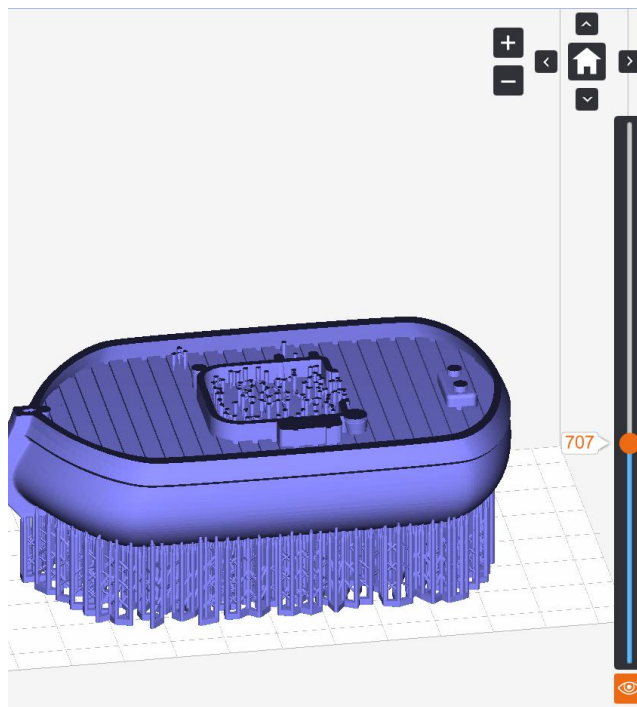

## Cross Section View

Once the model is loaded, you can drag the scroll bar on the right to see the cross section and internal details of the model at different Z-axis values.



## 2. Import Model File

Double-click the desktop  icon to open the NovaMake software, click  on the upper right corner of the software and select “Open” to import the 3D model you want to print. You can also drag and drop the file directly into the software printing platform area. The supported file types are .stl, .obj, and .3mf. Multiple models can be loaded in one scene. Import 3D model file, and select the model with the left mouse button to zoom, move, add support, and transfer files. The commonly used jewelry design software exports models in .slc format that can be used directly for printing.

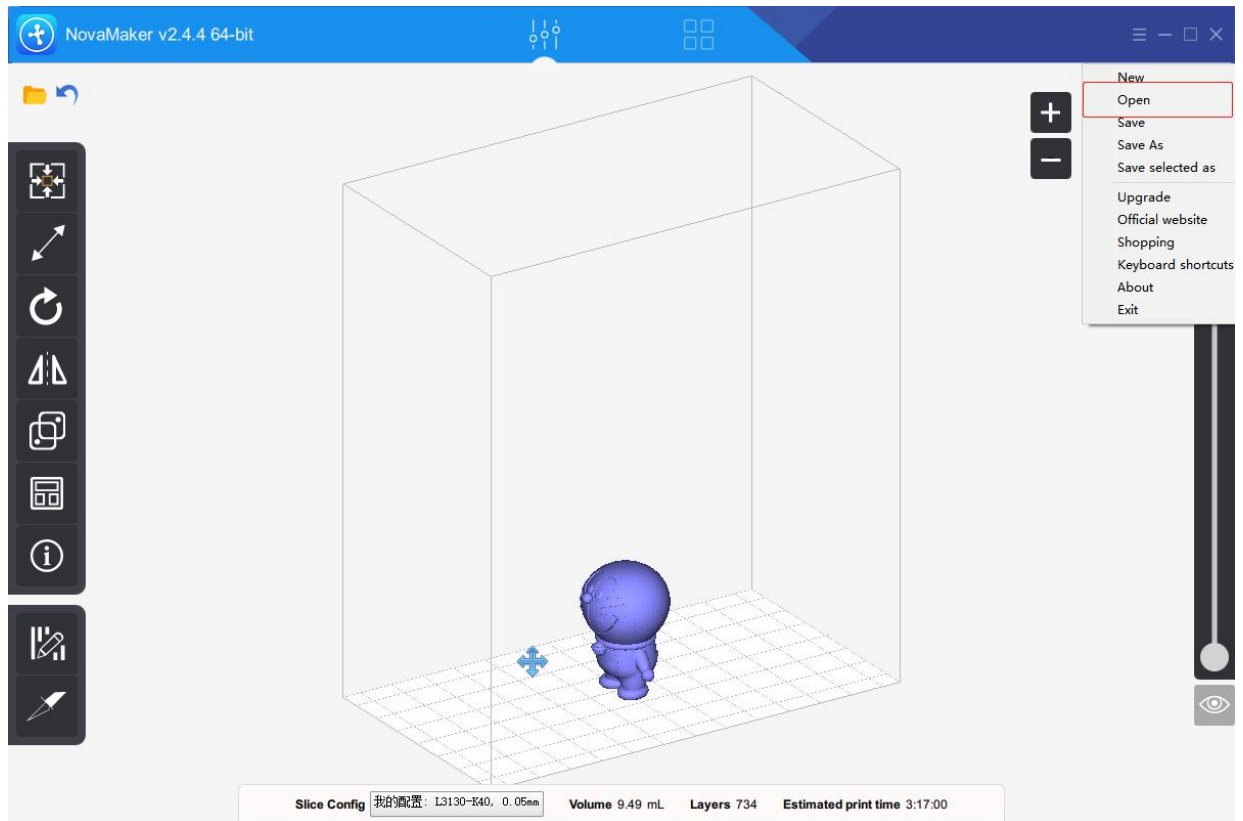

## 3. Adding Support

### 3.1. Auto Support&Manual Support

#### 3.1.1. Auto Support

The software provides an intelligent support algorithm. When the model structure is complicated, the auto support can be applied, the auto-generated support can meet most printing needs. To ensure the success of printing, you can also increase the support density for the lowest point part of the model.

#### 3.1.2. Manual Support

When the model structure is relatively simple, you can choose manual support, and add support at the lowest point part of the model.

### 3.2. Other Support Configuration

Thickness:

: Add a base plate to the model and set the thickness of the base plate (reference range 0.2-0.6mm).

: Here you can delete all the generated supports (select a support and press the DEL key to delete the specific support)

Tip: The action will be only for the **selected** models

#### Support bottom

Model move Z:   Shape:   
Thickness:

#### Auto support

Spacing:

#### Manual support

Click to start manually add support

#### Support shape

 Radius:  Height:   
Head top:  Head:   
Head bottom:   Connecting Rod

**Support shape:** Set the support radius and height, which can be adjusted according to the size of the object, suggested value:

1. Head top: 0.5-0.8mm
2. Head bottom: 0.7-1.5mm
3. Height: 1-2mm

Example:

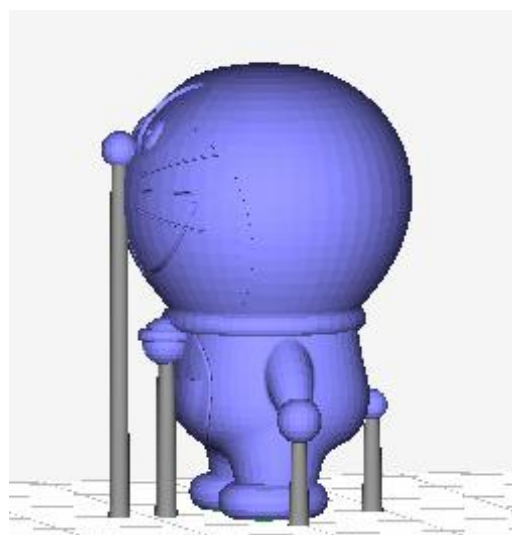

**Umbrella-shaped support :** ① top multi-point: Hold down “shift” to select the point where you want to add support (2 points or more), and finally release shift when you select the drop point.② point-to point: Hold down “shift” to select one point where you want to add support, and finally release the shift when you select the drop point. Set the support top and bottom radius and support height.

Before the support is added, the adjustment of the position and angle of the model is very helpful for printing. Generally follow the principle of heavy head down, because it is printed from bottom to top layer by layer, which can provide better support against gravity.

### **Principles:**

Theory one: Theoretically, any angle layout model can be successfully printed by adding support.

Theory two: Choose the optimal layout direction and angle.

Theory three: In some cases, there is no need to add support.

Theory four: Support to the lowest point part of the model is a must.

Theory five: If the upper part is continuous and the slope is large, support is only needed at the lowest point part, the upper part does not need to be supported.

Theory six: Overall stress of the model should be taken into consideration while determining how many support to add.

## **4. Slice Configuration**

The .slc file does not need to be sliced and can be directly uploaded to print. The .stl file needs to be added with support, sliced, and then uploaded for printing. NovaMake is the only slicing software for Nova3D printers. If you use other software to add support, you need to export the model to a file in .stl format and then import it into NovaMake software for slicing.

## 4.1. Set Printing Parameters

Parameter configuration is required before slicing. Even for the same model, different parameters need to be set if printed with different resin materials.

The default parameters are grayed out and cannot be changed. Click on “clone”. The cloned data can be modified corresponding to the material used. (Setting steps as shown below)

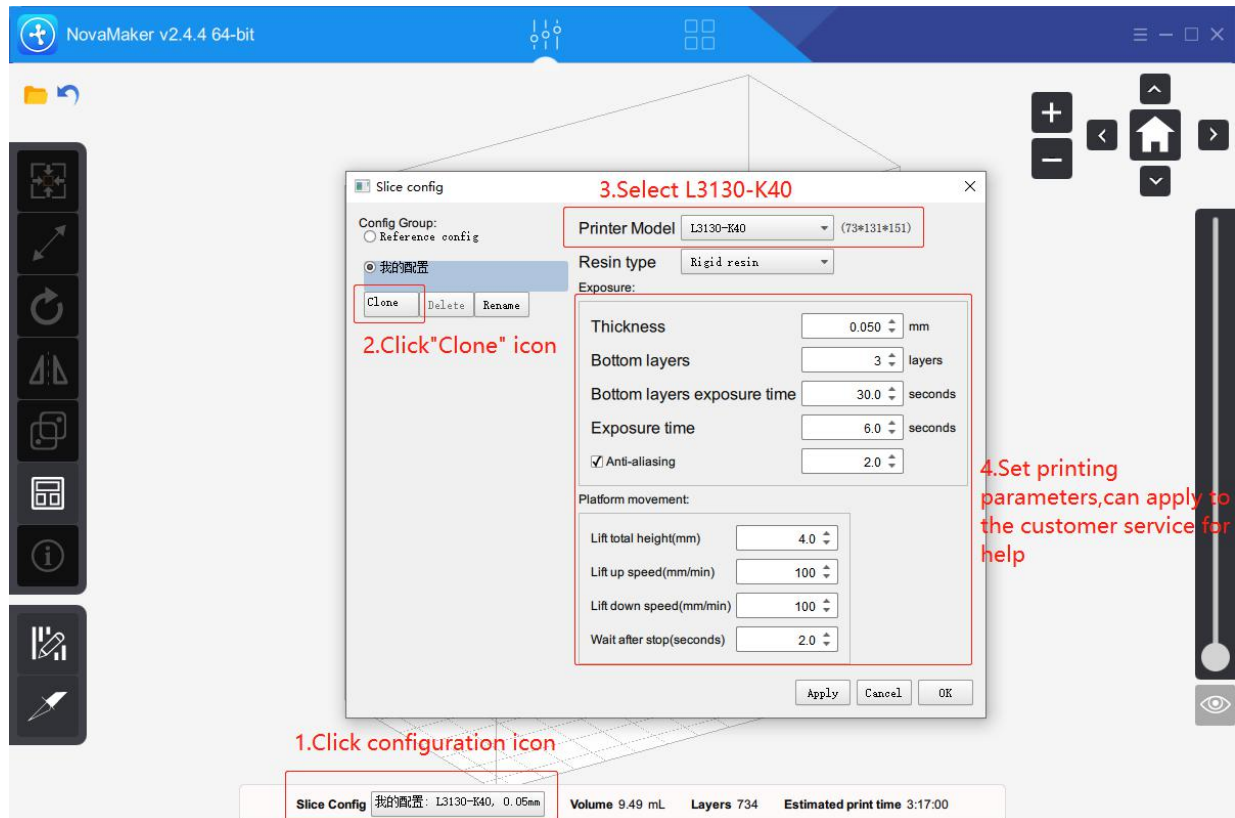

## 4.2. Parameter Setting Considerations

(1) When printing with Elfin, check the slicing software version at the upper left, the version needs to be above 2.4.2. If the version is below 2.4.2, please contact customer service to provide the latest software version.

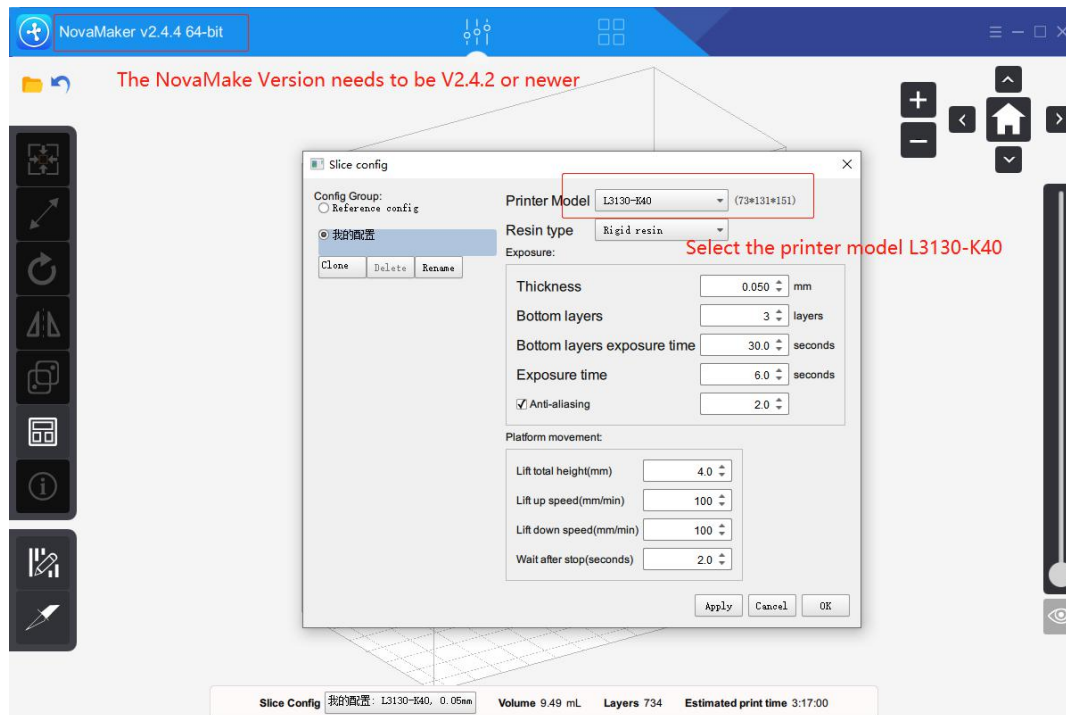

(2) Select printer model “L3130-K40”, other models correspond to the other printers of Nova3D.

(3) The layer thickness is generally selected to be 0.05mm, taking into account accuracy, printing time, and hardware characteristics. 0.05mm is almost the most reasonable choice.

(4) The exposure time and bottom layers exposure time are related to the resin. The default value is the optimum value after testing, the user can adjust according to the actual effect. (Note: The maximum exposure time is 150 seconds).

Click the “Slice” icon, select a file directory, enter the name of the saved file, and click "Save" to wait for the end of the slice.

## 5. Connectivity

### 5.1. Ethernet Connection:

Click  on the right side of NovaMake title bar to enter the printer management interface, then click "+" on the upper right side to display a pop-up box for "Printers Add Guidelines", select the first item (the printer has not been configured on the network...) and then click “Next” until you are prompted to add the printer successfully.





## 5.2. WIFI Connection:

After connecting WiFi in the device "Network Settings", Click  on the right side of NovaMake title bar to enter the printer management interface, then click "+" on the upper right side to display a pop-up box for "Printers Add Guidelines", select the second item (the printer has been configured WIFI...) as showed below, next, enter the current IP of the device until WIFI connected.

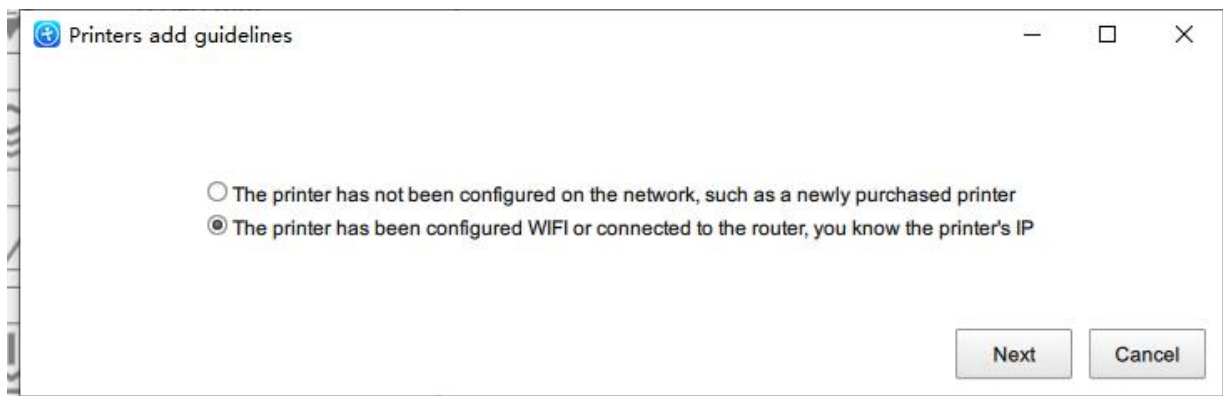

## 6、 Uploading Slice File

After connecting the device, Click “Printables” icon on the left side to import the .cws file just sliced, the uploaded file will appear in the file list, select the file, click Print to start the print job.

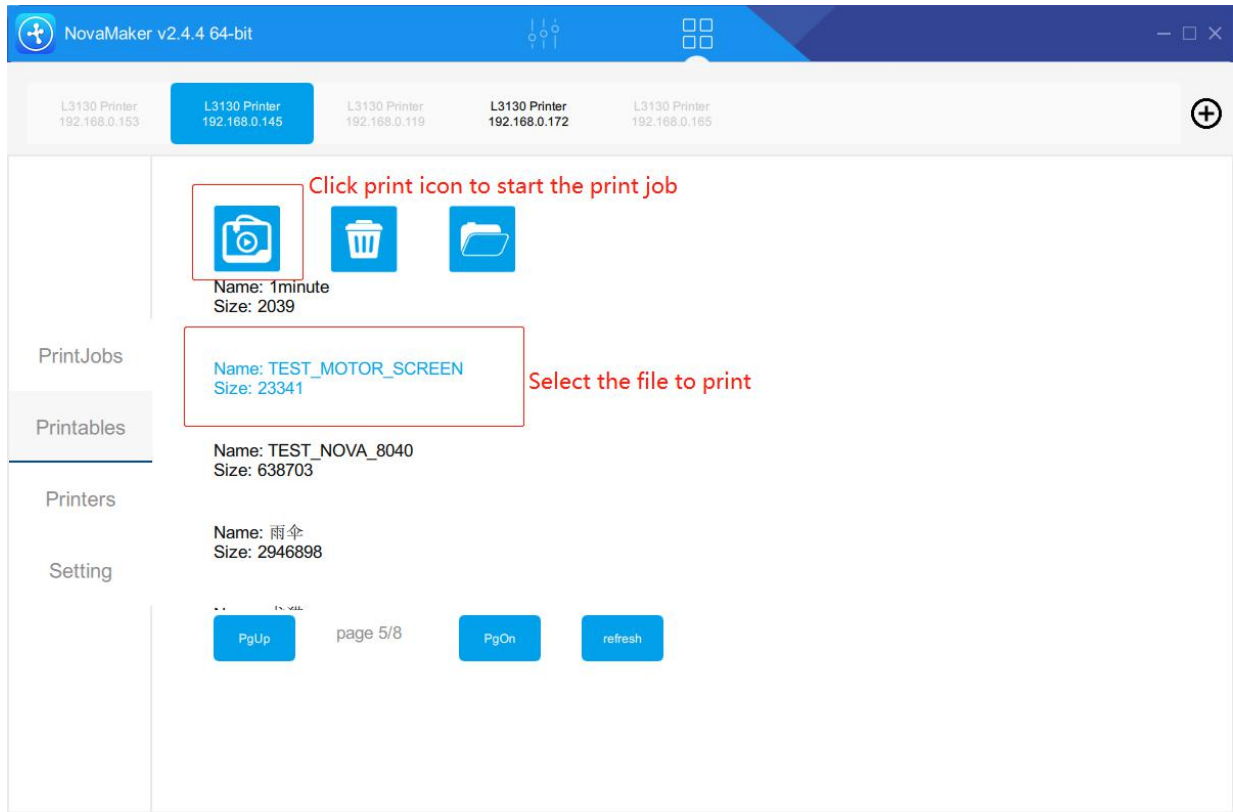

The screenshot shows the NovaMaker v2.4.4 64-bit software interface. At the top, there is a header bar with the software name and version, and a navigation menu with icons for printer management, print jobs, and settings. Below the header, there is a list of five L3130 Printers with their respective IP addresses. The main content area is divided into several sections: PrintJobs, Printables, Printers, and Setting. The PrintJobs section is currently selected and displays a list of print jobs. A red box highlights the '1minute' job, with a red arrow pointing to the print icon and the text 'Click print icon to start the print job'. Another red box highlights the 'TEST\_MOTOR\_SCREEN' job, with a red arrow pointing to the job name and the text 'Select the file to print'. The Printables section shows a job named 'TEST\_NOVA\_8040'. The Printers section shows a job named '雨伞'. The Setting section is currently empty. At the bottom of the interface, there are navigation buttons: 'PgUp', 'page 5/8', 'PgOn', and 'refresh'.

## 10. Starting and Post-Processing

### Caution!

Wear gloves and glasses during all procedures!

Printing and post-processing waste, including empty bottles, failed prints, supports, rafts as well as paper towels with resin residues should be put in the UV Station or in any source of UV light before disposal. Uncured resin has to be disposed of in accordance with national and local regulations concerning hazardous waste.

Detailed information regarding usage and waste disposal of the liquid detergent utilized to clean 3D prints should be found in the MSDS delivered by the producer of the liquid.

### a. Preparation for Printing

#### Check the LCD screen for proper operation

Remove the platform (as shown in the picture below), loosen the fixed knob above the platform, and hold the top of the platform with your hand to pull it out. Click the "Settings" of the home page, enter the "LCD Screen Check", and then check the LCD screen for proper operation according to the prompt.

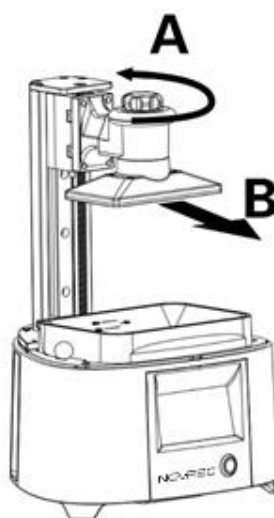

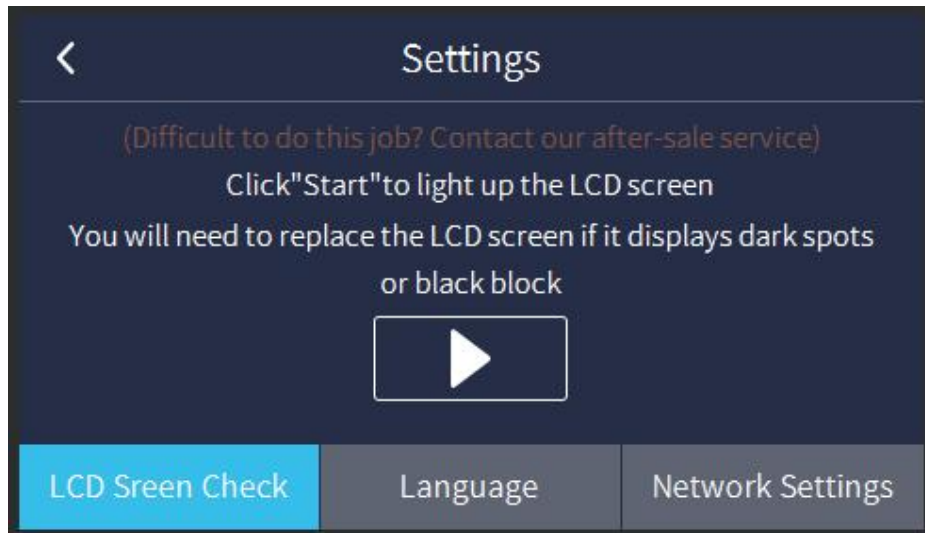

## b. Starting

Remove the UV cover

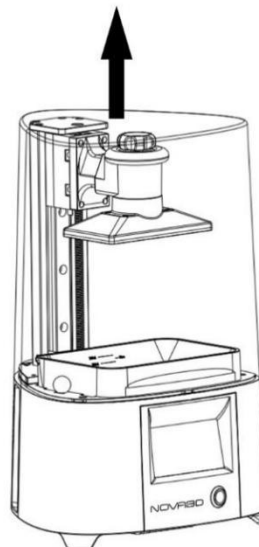

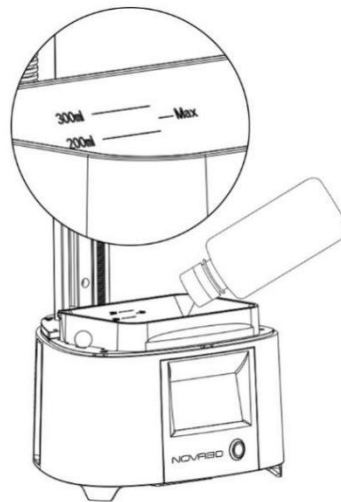

Fill the vat with resin. The resin level must fit the MIN and MAX marks.



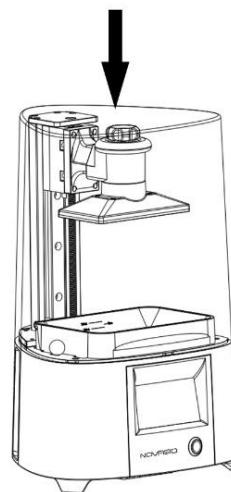

Install the UV cover back on the printer.

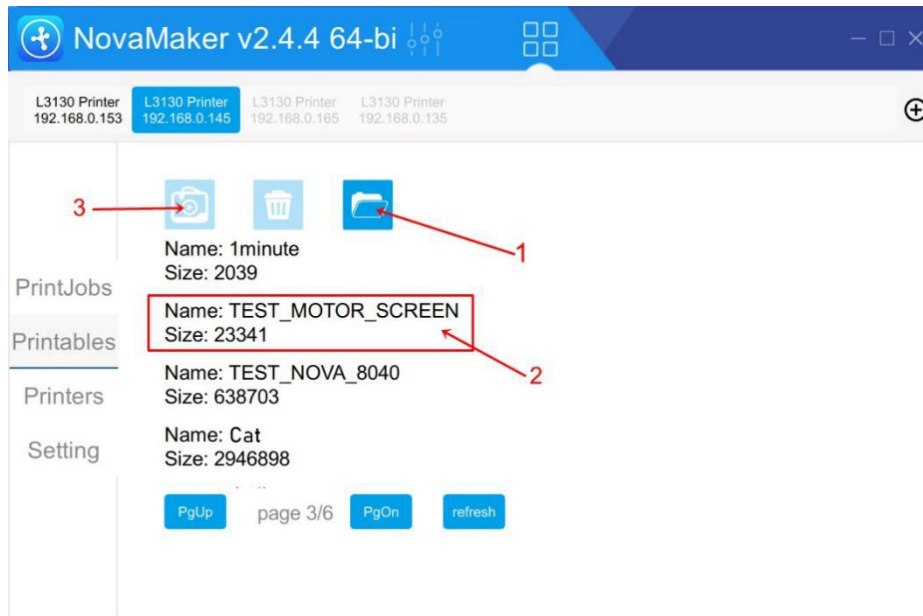

1. Transfer the file from NovaMake to the printer (via Wi-Fi /Ethernet or using the USB drive) and start the printing process. Transfer files from NovaMake to the printer via WIFI or Ethernet.

Enter the device management interface and click  to open the file, select the sliced .CWS file in the computer, it will be displayed in the list after uploading, select the file just uploaded and choose  to start printing



2. Save the sliced .CWS file on a USB flash drive and plug it into the port at the back of the device; Operate "File" on the printer touch screen to browse files in the USB flash drive or the device memory, click the upload icon  on the left, and the device will start printing after copying files to the print list of the machine.

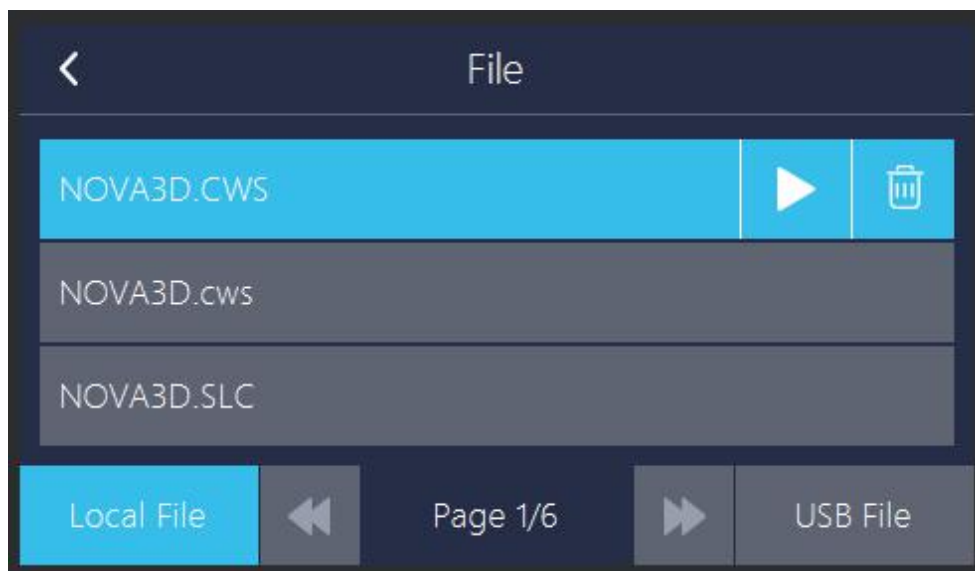

3. Once the printing process is finished, wait until the resin fully drains off of the model. Remove the UV cover.

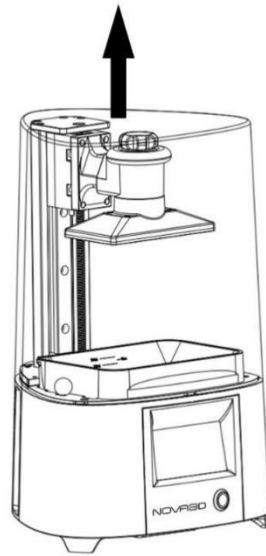

4. Wipe the top and edges of the platform with a paper towel and unscrew the platform screw. Remove the platform. Be careful not to spill the liquid resin on the printer and its surroundings.

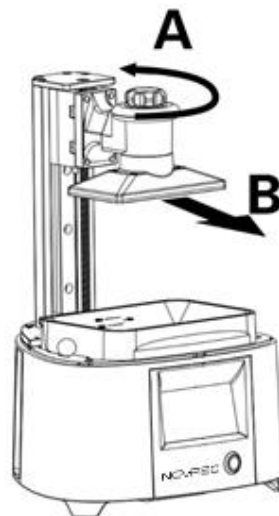

5. Install the UV cover on the printer to prevent the UV light from curing the resin in the vat.

### c. Post-Processing

1. Wear safety gloves and use a cutting knife to carefully remove the model from the platform. Then clean it with high concentration of industrial alcohol (above 95%) and blow-dry the surface alcohol. The cleaning is finished until the surface of the model is dry without oily. Otherwise, follow the steps above to continue cleaning and blow-drying. Be careful not to expose the model to the UV light before cleaning.

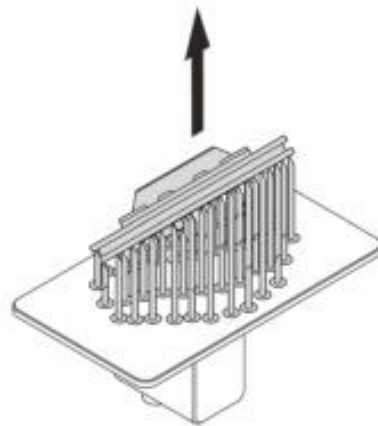

2. Put the model in the Curing box or in any source of UV light (e.g. direct sunlight). Depending on the type of resin you've used for printing and the application requirements, this step is optional.

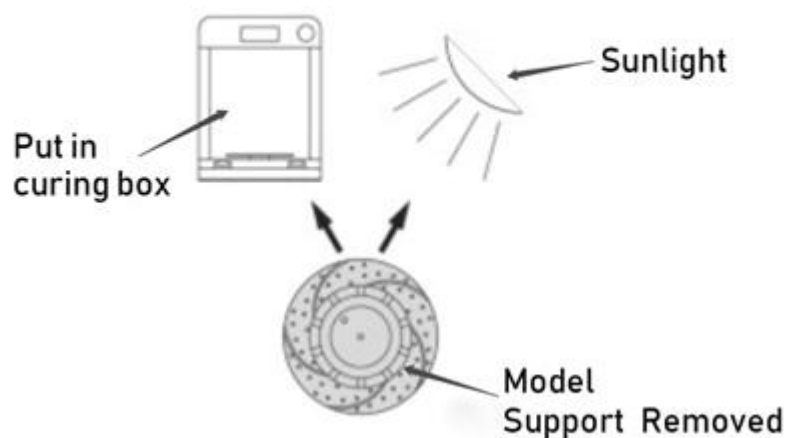

3. Remove the resin vat and pour the resin left in the vat through the filter and funnel. If it's necessary, use a plastic spatula. Once you finish, clean the resin filter in a liquid detergent. If



it's necessary, you can also clean the resin vat using the same liquid.



4. Clean the resin vat with a paper towel. You can also use resin detergent and 99% isopropyl alcohol for that purpose.

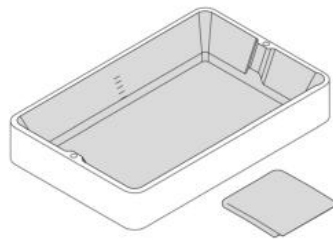

5. Clean the platform, LCD screen and the resin vat. After that, reinstall the resin vat into the printer and fasten it, and then install the platform back to the Z-Axis guide of the printer and secure it with the screw.

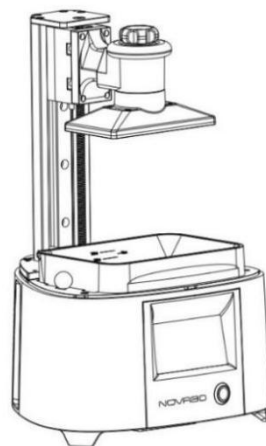

6. Install the UV cover back on the printer.

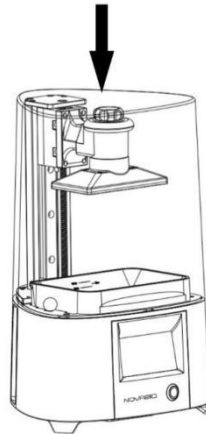

### d. Changing the Resin

1. Remove UV cover from bottom to top.

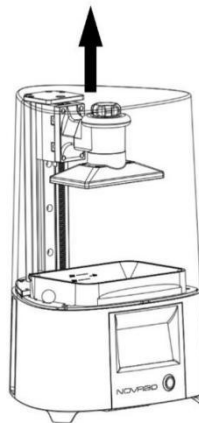

2. Refer to the following diagram, move the spherical button on both sides of the resin vat inward. Next, remove the vat.

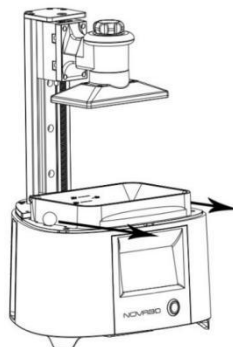

3. Insert the resin filter into the silicone funnel and put them together in the bottle with resin. Pour the resin left in the vat through the filter and funnel. If it is necessary, use a plastic spatula. Once you finish, clean the resin filter and the resin vat in a liquid detergent or isopropyl alcohol.



**NOTE!** It is advisable to filter the already used resin after each print. Mix it with the fresh resin to make sure that there are no cured remains in the liquid, as they could have a negative influence on the quality of the next print and shorten the resin lifespan.

1. Clean the resin vat with a paper towel. You can also use 99% isopropyl alcohol for that purpose.

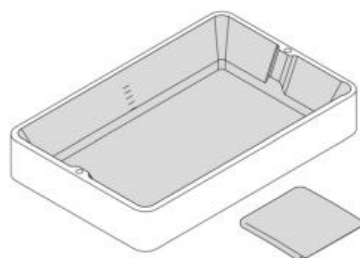

2. Clean the platform, LCD screen and the resin vat. After that, install the resin vat back into the printer and fasten the spherical button on both sides to fix it.

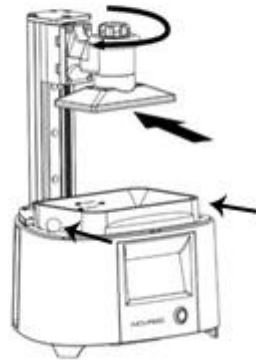

3. Fill the vat with new resin. The resin level must fit the MIN and MAX marks.

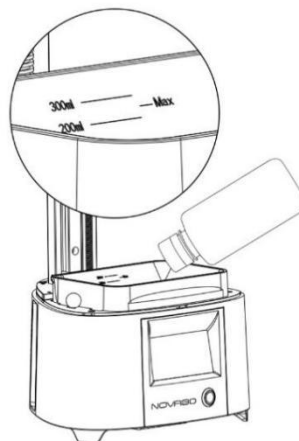

4. Install the UV cover back on the printer.

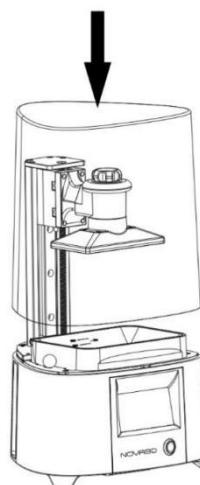

## 11. Available Materials

The complete offer of materials is available at: <http://www.nova3dprinter.com/material.html>  
*Material Technical Data Sheets* and *Safety Data Sheets* can be found at the same website.

When 3D printing with the Nova3D ELFIN, the Manufacturer recommends using Nova3D certified materials, ensure that the resin packaging is intact and to check whether the resin is within its lifespan to acquire the best possible quality of prints.

## 12. Basic Maintenance and Service Work

Maintenance work should be regular in order to keep the printer in good condition and achieve high quality prints every time. Some parts require maintenance before each print and some every few hundred working hours. All maintenance activities do not take much time and are not complicated. Before commencing any repair, remember to always wear gloves and glasses. The printer is delivered with a full set of tools needed to carry out maintenance service work. The following tables present maintenance and repair guidelines connected with each section of the Nova3D ELFIN, together with specific check points, necessary activities and their frequency.

Activity	Frequency	Solutions to the problems	Necessary accessories
Cleaning the machine, its Interior and surroundings	Before each Printing process	Remove dust and drops of resin from the machine with paper towels. If it's necessary, use IPA	Dust-free cloth, rubber gloves, detergent/alcohol
Cleaning the LCD Screen	Every time the resin vat is removed	Soak a paper towel in IPA and clean the LCD screen.	Paper towels detergent
Cleaning the UV cover	Once a week	Clean the cover from dust using a dust-free cloth.	Dust-free cloth, Rubber gloves, detergent
Cleaning the underside of the FEP film	Every time the resin vat is removed	Soak a paper towel in IPA and clean the underside of the FEP film.	paper towels, IPA, Rubber gloves
Checking if there are residues of cured resin on the FEP film	Before each Printing process	Use a plastic spatula and slightly mix the resin to check if there are any residues in the liquid.	a plastic spatula, rubber gloves
Emptying and cleaning the resin vat	Every time the resin type or color is changed	Insert the resin filter into the silicone funnel and pour the resin left in the vat into the bottle.	resin filter, silicone funnel, bottle of resin, paper towels, a plastic spatula, detergent/IPA
Replacing the FEP film	Once the FEP film Becomes bent, deformed, or perforated	Follow the FEP film replacement instructions	a new FEP film, Hex wrench

Checking if there are residues of cured resin on the platform	Before each Printing process	Soak a dust-free cloth in IPA and clean the surface of the platform.	A dust-free cloth, IPA
Check if the platform properly adheres to the LCD screen (Calibrate to be parallel to the platform)	After each failed print	After remove the resin vat, put a piece of A4 paper on the LCD screen, and select platform lift and return function. If the paper can jerk at the four corners of the LCD screen with slight resistance, it is ok.	a piece of A4 paper
Check the LCD screen (screen test)	Before each Printing process	Click the "Settings" icon on the home page, then click "LCD Screen Check"	Visually observe whether there are black spots on the screen under a solid color background.

## 13. Support and Troubleshooting

In order to ensure safety of every 3D printer's user, the Manufacturer provides various support while identifying and solving technical problems independently. In case of difficulties with operating a Nova3D printer, at first you should seek guidance in this User Guide, check the manuals available at: <http://www.nova3dprinter.com/docs/index.html>

The most common problems are listed below along with the list of possible solutions.

- The print does not adhere to the platform during the printing process:

1. Make sure that the model has been designed properly and its mesh does not contain any errors. Make sure that while preparing the file in NovaMake you chose an appropriate printing profile, that is, the print settings match the type of used resin. If the profile is correct, increase the *Layer Exposure Time* in NovaMake or in the printer's menu during the printing process.

2. Make sure that both the platform and the FEP film are clean, that is, there are no residues of cured resin on them. Filter the already used resin and mix it with the fresh resin to make sure that there are no cured remains in the liquid.

3. Prepare a sheet of sandpaper (grit >160) and put it on a flat surface. Place the platform on the paper and smooth its surface in a circular motion.

4. Check if the FEP film is not bent, deformed, or perforated. Replace the FEP film if you notice such defects.

5. Make sure that the platform properly adheres and parallel to the LCD screen. If not, please readjust the platform to be placed at the correct distance from the LCD screen.

6. Contact the Support Center at: <http://www.nova3dprinter.com/docs/index.html>

- The print delaminates or it does not adhere to the platform:

1. Make sure that the model has been designed properly and its mesh does not contain any errors.



2. If the support structures have been generated in a different program than NovaMake, make sure that the model's mesh is fixed and the raft properly adheres to the platform.
3. Make sure that the print has been properly prepared in NovaMake, that is, its size and plane dimension are within the print range. Each layer that should be parallel to the platform, proper support size not too small to ensure successful printing.
4. Make sure that while preparing the file in NovaMake you chose an appropriate printing profile, that is, the print settings match the type of used resin. If the profile is correct, enable *Additional support exposure time* option and decrease the *Platform lift speed* in the Parameter setting menu.
5. Check if the FEP film is not bent, deformed, or perforated. Replace the FEP film if you notice such defects.
6. Contact the Support Center at: <http://www.nova3dprinter.com/docs/index.html>

## 14. Specification

<b>Weight and Physical Dimensions</b>	
Device (W x D x H)	270*260*420mm
Shipping box	340*340*518mm
Device net weight	7.3KG
Device gross weight	8.6 KG
<b>Printer</b>	
Technology	UV LCD
Layer thickness	0.025/0.035/0.05/0.1mm
Print speed	30-40mm/h (Max)
<b>Device</b>	
Build volume	130*70*150mm
Support	Automatic/manual
Light source	UV integrated light (wavelength 405 nm)
Connectivity	Wi-Fi, Ethernet, USB flash drive
Operating system	Android
Processor	Cortex A7 1.5G Quad-core Cortex A7 1.5G
RAM	1.00GB
Storage capacity	8.00GB 8.00GB (including system files)
Touch screen	4.3 "capacitive touch screen
Available materials	Nova Whole series of Nova resin
External materials	Applicable
<b>Temperature</b>	
Ambient operation temperature	20 - 30° C (68 - 86° F) 20 - 30° C (68 - 86° F)
Storage temperature	0 - 35° C (32 - 95° F)
<b>Electrical power</b>	
Ac Adapter	100-240V~ 50/60Hz 2.0A Input 100-240V~ 50/60Hz 2.0A

	12V DC /5.0A Output 12V DC /5.0A
Maximum power consumption	60W
<b>Software</b>	
Software bundle	NovaMake
Supported 3D file types	.stl, .obj, .nmk
Supported formats	.cws,.slc
Supported operating systems	Mac OS X / Windows 7 Mac OS X / Windows 7 and newer versions
<b>Additional information</b>	
All information contained in this User Guide and specification is subject to change without notice.	

## 15. Recycling

### Disposal of paper and plastic packaging

To protect the environment, the Manufacturer recommends placing used paper and plastic packaging in specially designated containers, according to your local recycling guidelines.

### Disposal of resin

Printing and post-processing waste, including empty bottles, failed prints, supports, rafts as well as paper towels with resin residues should be put in the UV Station or in any source of UV light before disposal. Uncured resin has to be disposed of in accordance with national and local regulations concerning hazardous waste.

### Waste electrical and electronic equipment

This symbol indicates that it is electrical and electronic equipment which must not be disposed of with household waste. Substances contained in the equipment may be harmful to natural environment. Waste electrical and electronic equipment cannot be disposed of in landfills and must be recycled. For information on where to dispose of waste equipment, contact the reseller, the Manufacturer, or the importer of the device.

